



## Ultra-elegant Gigabit Color IP Phone SIP-T48G User Guide

# Copyright

**Copyright © 2014 YEALINK NETWORK TECHNOLOGY CO., LTD.**

Copyright © 2014 Yealink Network Technology CO., LTD. All rights reserved. No parts of this publication may be reproduced or transmitted in any form or by any means, electronic or mechanical, photocopying, recording, or otherwise, for any purpose, without the express written permission of Yealink Network Technology CO., LTD. Under the law, reproducing includes translating into another language or format.

When this publication is made available on media, Yealink Network Technology CO., LTD. gives its consent to downloading and printing copies of the content provided in this file only for private use but not for redistribution. No parts of this publication may be subject to alteration, modification or commercial use. Yealink Network Technology CO., LTD. will not be liable for any damages arising from use of an illegally modified or altered publication.

## Warranty

THE SPECIFICATIONS AND INFORMATION REGARDING THE PRODUCTS IN THIS GUIDE ARE SUBJECT TO CHANGE WITHOUT NOTICE. ALL STATEMENTS, INFORMATION, AND RECOMMENDATIONS IN THIS GUIDE ARE BELIEVED TO BE ACCURATE AND PRESENTED WITHOUT WARRANTY OF ANY KIND, EXPRESS OR IMPLIED. USERS MUST TAKE FULL RESPONSIBILITY FOR THEIR APPLICATION OF PRODUCTS.

YEALINK NETWORK TECHNOLOGY CO., LTD. MAKES NO WARRANTY OF ANY KIND WITH REGARD TO THIS GUIDE, INCLUDING, BUT NOT LIMITED TO, THE IMPLIED WARRANTIES OF MERCHANTABILITY AND FITNESS FOR A PARTICULAR PURPOSE. Yealink Network Technology CO., LTD. shall not be liable for errors contained herein nor for incidental or consequential damages in connection with the furnishing, performance, or use of this guide.

## Declaration of Conformity



Hereby, Yealink Network Technology CO., LTD. declares that this phone is in conformity with the essential requirements and other relevant provisions of the CE, FCC.

## CE Mark Warning

This device is marked with the CE mark in compliance with EC Directives 2006/95/EC and 2004/108/EC.

## Part 15 FCC Rules

This device is compliant with Part 15 of the FCC Rules. Operation is subject to the following two conditions:

1. This device may not cause harmful interference, and
2. This device must accept any interference received, including interference that may cause undesired operation.

## Class B Digital Device or Peripheral

Note: This device is tested and complies with the limits for a Class B digital device, pursuant to Part 15 of the FCC Rules. These limits are designed to provide reasonable protection against harmful interference in a residential installation. This equipment generates, uses, and can radiate radio frequency energy and, if not installed and used in accordance with the instructions, may cause harmful interference to radio communications. However, there is no guarantee that interference will not occur in a particular installation. If this equipment does cause harmful interference to radio or television reception, which can be determined by turning the equipment off and on, the user is encouraged to try to correct the interference by one or more of the following measures:

1. Reorient or relocate the receiving antenna.
2. Increase the separation between the equipment and receiver.
3. Connect the equipment into an outlet on a circuit different from that to which the receiver is connected.
4. Consult the dealer or an experienced radio/TV technician for help.

## WEEE Warning



To avoid the potential effects on the environment and human health as a result of the presence of hazardous substances in electrical and electronic equipment, end users of electrical and electronic equipment should understand the meaning of the crossed-out wheeled bin symbol. Do not dispose of WEEE as unsorted municipal waste and have to collect such WEEE separately.

## Customer Feedback

We are striving to improve our documentation quality and we appreciate your feedback. Email your opinions and comments to [DocsFeedback@yealink.com](mailto:DocsFeedback@yealink.com).

# GNU GPL INFORMATION

Yealink SIP-T48G IP phone firmware contains third-party software under the GNU General Public License (GPL). Yealink uses software under the specific terms of the GPL. Please refer to the GPL for the exact terms and conditions of the license.

The original GPL license, source code of components licensed under GPL and used in Yealink products can be downloaded online:

<http://www.yealink.com/GPLOpenSource.aspx?BaseInfoCatId=293&NewsCatId=293&CatId=293>.



## About This Guide

Thank you for choosing the SIP-T48G IP phone, an ultra-elegant gigabit IP phone which is exquisitely designed to provide business telephony features, such as Call Hold, Call Transfer, Busy Lamp Field, Call Recording, Multicast Paging and Conference over an IP network. Newly developed industrial designs and user experience appears the commerce, touch panel enabling switching between screens and application.

This guide provides everything you need to quickly use your new phone. First, verify with your system administrator that the IP network is ready for phone configuration. Also be sure to read the Packaging Contents and Regulatory Notices sections in this guide before you set up and use the SIP-T48G IP phone.

If this is your first time using the SIP-T48G IP phone, we recommend that you first refer to the *Quick Installation Guide* and *Quick Reference Guide*, available online:

[http://www.yealink.com/SupportDownloadfiles\\_detail.aspx?CatId=1206&flag=142](http://www.yealink.com/SupportDownloadfiles_detail.aspx?CatId=1206&flag=142).

### Note

Shared Line, Busy Lamp Field List, Network Directory and Network Call Log features are hidden for IP phones in neutral firmware, which are designed for BroadWorks environment. Please contact your system administrator for more information.

## In This Guide

Topics provided in this guide include:

- Chapter 1 [Overview](#)
- Chapter 2 [Getting Started](#)
- Chapter 3 [Customizing Your Phone](#)
- Chapter 4 [Basic Call Features](#)
- Chapter 5 [Advanced Phone Features](#)

## Summary of Changes

This section describes the changes to this guide for each release and guide version.

## Changes for Release 72, Guide Version 72.2

Major updates have occurred to the following sections:

- [Documentations](#) on page 7

- [Packaging Contents](#) on page 9

# Table of Contents

<b>About This Guide</b> .....	<b>ix</b>
In This Guide.....	ix
Summary of Changes.....	ix
Changes for Release 72, Guide Version 72.2 .....	ix
<b>Table of Contents</b> .....	<b>xi</b>
<b>Overview</b> .....	<b>1</b>
Hardware Component Instructions.....	1
Icon Instructions.....	2
LED Instructions .....	4
User Interfaces.....	5
Phone User Interface .....	5
Web User Interface.....	5
Documentations.....	7
<b>Getting Started</b> .....	<b>9</b>
Packaging Contents.....	9
Phone Installation.....	11
Phone Initialization.....	13
Registration .....	14
Touch Screen Display.....	14
Navigating Menus and Fields.....	16
Entering Data and Editing Fields .....	17
Phone Status.....	18
Basic Network Settings.....	19
<b>Customizing Your Phone</b> .....	<b>23</b>
General Settings.....	23
Wallpaper.....	23
Backlight.....	24
Contrast.....	25
Language.....	26
Time & Date.....	27
Administrator Password .....	30

Key as Send .....	31
Audio Settings.....	31
Volume.....	31
Ring Tones .....	32
Contact Management.....	34
Directory.....	34
Local Directory .....	36
Blacklist.....	51
Remote Phone Book.....	53
Call History Management.....	55
System Customizations.....	59
Headset Use .....	59
Bluetooth Headset.....	61
DSS Keys .....	67
Account Management .....	75
Dial Plan .....	78
Live Dialpad.....	83
Hotline .....	84
<b>Basic Call Features .....</b>	<b>87</b>
Placing Calls.....	88
Answering Calls .....	90
Ending Calls .....	91
Redialing Numbers .....	92
Recent Call In Dialing .....	92
Auto Answer.....	93
Auto Redial.....	94
Call Completion .....	95
Call Return.....	97
Call Mute.....	98
Call Hold/Resume .....	98
Do Not Disturb (DND) .....	99
Call Forward.....	104
Call Transfer .....	111
Call Waiting.....	113
Conference.....	113
Local Conference.....	114
Network Conference .....	115
Call Park .....	117
Call Pickup.....	118
Anonymous Call.....	122
Anonymous Call Rejection.....	123
<b>Advanced Phone Features .....</b>	<b>125</b>

---

Busy Lamp Field (BLF).....	125
Call Recording.....	128
Hot Desking.....	131
Intercom.....	132
Outgoing Intercom Calls .....	133
Incoming Intercom Calls.....	133
Multicast Paging .....	135
Sending RTP Stream .....	135
Receiving RTP Stream.....	137
Music on Hold .....	139
Messages.....	140
Voice Mail.....	140
Message Waiting Indicator (MWI) .....	142
<b>Troubleshooting .....</b>	<b>145</b>
<b>Regulatory Notices .....</b>	<b>155</b>
Service Agreements .....	155
Limitations of Liability.....	155
Safety Instructions.....	155
<b>Appendix A - Time Zones .....</b>	<b>157</b>
<b>Index.....</b>	<b>159</b>



# Overview

This chapter provides the overview of the SIP-T48G IP phone. Topics include:

- [Hardware Component Instructions](#)
- [Icon Instructions](#)
- [LED Instructions](#)
- [User Interfaces](#)
- [Documentations](#)





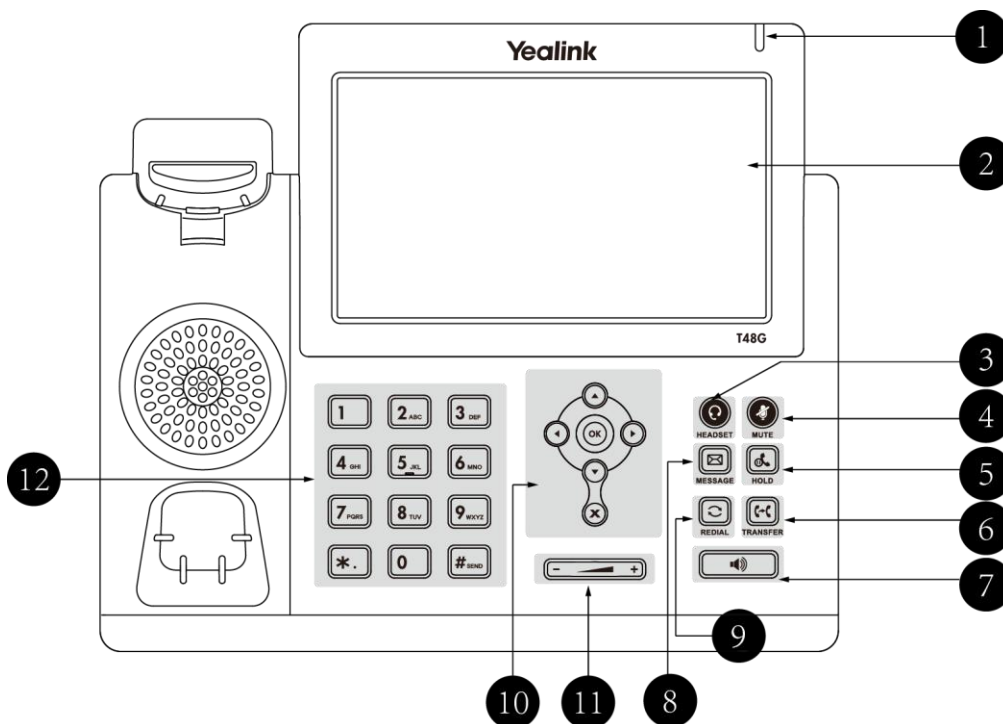

If you require additional information or assistance with your new phone, contact your system administrator.

## Hardware Component Instructions

The main hardware components of the SIP-T48G IP phone are the touch screen and the keypad.





Hardware component instructions of the SIP-T48G IP phone are:





















	Item	Description
①	Power Indicator LED	Indicates phone power and some feature statuses.
②	Touch Screen	Shows information about calls, messages, soft keys, time, date and other relevant data: <ul style="list-style-type: none"> <li>• Call information—caller ID, call duration</li> <li>• Icons (for example, )</li> <li>• Missed call text or second incoming caller information</li> <li>• Prompt text (for example, "Saving file...")</li> <li>• Time and date</li> </ul>
③	HEADSET Key	Toggles and indicates the headset mode.
④	MUTE Key	Toggles and indicates mute feature.
⑤	HOLD Key	Places a call on hold or resumes a held call.
⑥	TRANSFER Key	Transfers a call to another party.
⑦	Speakerphone Key	Toggles the hands-free speakerphone mode.
⑧	MESSAGE Key	Accesses voice messages.
⑨	REDIAL Key	Redials a previously dialed number.
⑩	 	Position the cursor. Enable or disable fields.
	 	Turn pages or scroll through values for a field. Scroll through items.
		Confirms actions or answers incoming calls.
		Cancels actions or rejects incoming calls.
⑪	Volume Key	Adjusts the volume of the handset, headset, speaker and ringer.
⑫	Keypad	Provides the digits, letters and special characters in context-sensitive applications.







## Icon Instructions

Icons appearing on the touch screen are described in the following table:

Icons	Description
	Network is unavailable
	Registered successfully
	Register failed



Icons	Description
 (Flashing)	Registering
	Hands-free speakerphone mode
	Handset mode
	Headset mode
	Multi-lingual lowercase letters input mode
	Multi-lingual uppercase letters input mode
	Alphanumeric input mode
	Numeric input mode
	Multi-lingual uppercase and lowercase letters input mode
	Voice Mail
	Auto Answer
	Do Not Disturb
	Call Forward
	Call Hold
	Call Mute
	Ringer volume is 0
	Received Calls
	Placed Calls
	Missed Calls
	Forwarded Calls
	Recording box is full

Icons	Description
	A call cannot be recorded
	Recording starts successfully
	Recording cannot be started
	Recording cannot be stopped
	Bluetooth mode is on
	Bluetooth headset is both paired and connected
	The default caller photo and contact icon

## LED Instructions

### Power Indicator LED

LED Status	Description
Solid red	The phone is initializing.
Fast flashing red	The phone is ringing.
Slow flashing red	The phone receives a voice mail.
Off	<p>The phone is powered off.</p> <p>The phone is idle.</p> <p>The phone is busy.</p> <p>The call is placed on hold or is held.</p> <p>The call is mute.</p>

### Note

The above introduces the default power indicator LED status. The status of the power indicator LED is configurable via web user interface. For more information, refer to *Yealink\_SIP-T4X\_IP\_Phone\_Family\_Administrator\_Guide\_V72\_2*.

## User Interfaces

Two ways to customize configurations of your SIP-T48G IP phone:

- The user interface on the IP phone.
- The user interface in a web browser on your PC.

The hardware components keypad and touch screen constitute the phone user interface, which allows the user to execute all call operation tasks and basic configuration changes directly on the phone. In addition, you can use the web user interface to access all configuration settings. In many cases, it is possible to use either the phone user interface and/or the web user interface interchangeably. However, in some cases, it is only possible to use one or the other interface to operate the phone and change settings.

## Phone User Interface

You can customize your phone by tapping the Menu soft key to access the phone user interface. The Advanced option is only accessible to the administrator, and the default administrator password is “admin” (case-sensitive). For more information on customizing your phone with the available options from the phone user interface, refer to [Customizing Your Phone](#) on page 23.

## Web User Interface

In addition to the phone user interface, you can also customize your phone via web user interface. In order to access the web user interface, you need to know the IP address of your new phone. To obtain the IP address, press the OK key on the phone. Enter the IP address (e.g., http://192.168.0.10 or 192.168.0.10) in the address bar of web browser on your PC. The default administrator user name and password are both “admin” (case-sensitive).

The main options you can use to customize the IP phone via phone user interface and/or via web user interface are listed in the following table:

Options	Phone User Interface	Web User Interface
<b>Status</b>		
--IPv4		
--MAC		
--Firmware	√	√
--Network		
--Phone		
--Accounts		
<b>Basic Call Features</b>		

Options	Phone User Interface	Web User Interface
--Auto Answer	√	
--Auto Redial	√	
--Call Completion	√	
--Call Forward	√	
--Call Waiting	√	
--Call Park	√	
--Call Pickup	√	
--Call Return	√	
--Conference		
--Anonymous Call	√	
--Anonymous Call Rejection	√	
--DND	√	
<b>Basic Phone Settings</b>		
--Language	√	√
--Time & Date	√	√
--Administrator Password	√	√
--Ring Tones	√	√
--Wallpaper	√	√
--Backlight	√	√
--Call History Management	√	
--Contact Management		√
--Local Directory	√	√
--Blacklist	√	√
--Remote Phone Book		√
--LDAP		√
--Dial Plan		√
--DSS Keys	√	√
--Key as Send	√	√
--Hotline	√	√
--Live Dialpad		√
<b>Advanced Phone Features</b>		
--BLF	√	
--Call Recording	√	
--Hot Desking	√	
--Intercom	√	√
--Multicast Paging		
--Music on Hold		
--Messages	√	
<b>SIP Account</b>		
--User Options		√
--Register Status	√	

Options	Phone User Interface	Web User Interface
--Account Status	√	
--Label	√	
--Display Name	√	
--Register Name	√	
--User Name	√	
--Password	√	
--SIP Server 1/2	√	
--Server Option		
--Registrar Port		
--Outbound Status	√	
--Outbound Proxy	√	
--NAT Traversal		
--STUN Status	√	
--STUN Server	√	

**Note** The table above lists most of the feature options. Please refer to the relevant sections for more information.

## Documentations

The following table shows documentations available for the SIP-T48G IP phone.

Name	Contents	Where found	Language
Quick Installation Guide	Basic setup of the phone	In the package	English
Quick Reference Guide	Basic call features and phone customizations	In the package	English
User Guide	Phone/Web user interface settings Basic call features and advanced phone features	On the website	English

**Note** You can also download the latest documentations online:  
[http://www.yealink.com/SupportDownloadfiles\\_detail.aspx?CatelId=1206&flag=142](http://www.yealink.com/SupportDownloadfiles_detail.aspx?CatelId=1206&flag=142).



# Getting Started

This chapter provides the following basic installation instructions and information for obtaining the best performance with the SIP-T48G IP phone. Topics include:

- [Packaging Contents](#)
- [Phone Installation](#)
- [Phone Initialization](#)
- [Phone Status](#)
- [Basic Network Settings](#)
- [Registration](#)
- [Touch Screen Display](#)

If you require additional information or assistance with your new phone, contact your system administrator.

## Packaging Contents

The following components are included in your SIP-T48G IP phone package:

- **SIP-T48G IP Phone**

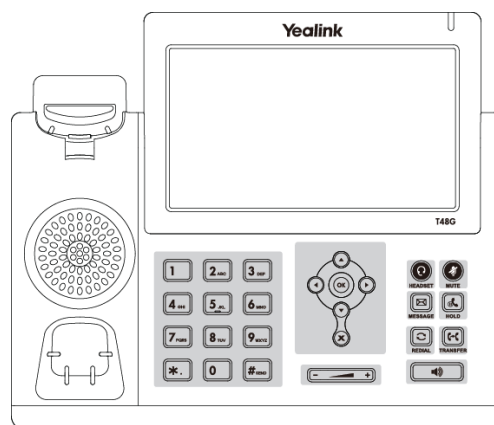

- **Phone Stand**

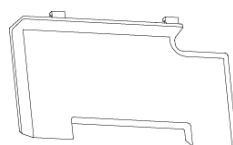

- **Wall Mount Bracket (Optional)**

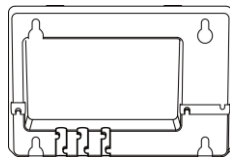

- **Power Adapter (Optional)**

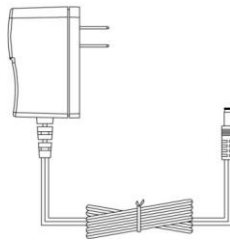

- **Handset & Handset Cord**

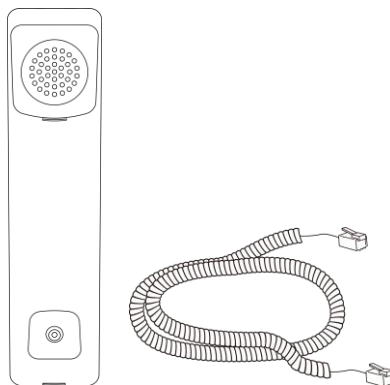

- **Ethernet Cable**

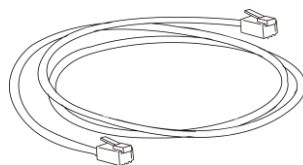

- **Quick Installation Guide & Quick Reference Guide**

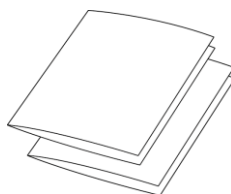

Check the list before installation. If you find anything missing, contact your system administrator.



## Phone Installation

If your phone is already installed, proceed to [Phone Initialization](#) on page 13.

This section introduces how to install the phone:

- 1) Attach the stand or the optional wall mount bracket
- 2) Connect the handset and optional headset
- 3) Connect the network and power

### 1) Attach the stand or the optional wall mount bracket

#### Desk Mount Method

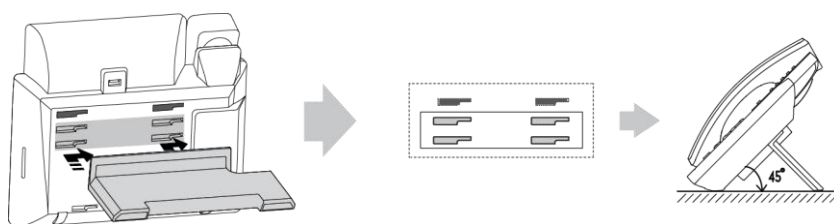

#### Wall Mount Method (Optional)

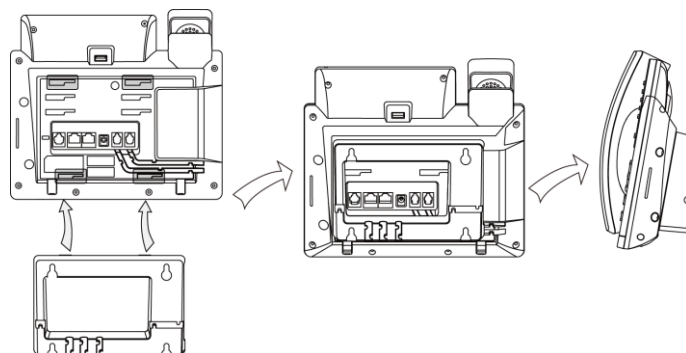

#### Note

The wall mount bracket should be purchased separately.

The top two slots are plugged up by silica gel. You need to pull out silica gel before attaching the wall mount bracket. For more information on how to mount your phone to a wall, refer to *Yealink Wall Mount Quick Installation Guide for T4X IP Phones*.

## 2) Connect the handset and optional headset

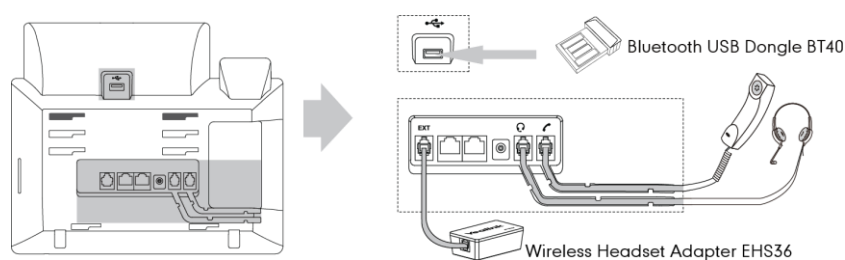

### Note

The headset, wireless headset adapter EHS36 and Bluetooth USB Dongle BT40 should be purchased separately.

The EXT port can also be used to connect an expansion module EXP40.

For more information on how to use EHS36, EXP40 and Bluetooth USB Dongle BT40, refer to Yealink EHS36 User Guide, Yealink EXP40 User Guide and Yealink Bluetooth USB Dongle BT40 User Guide.

## 3) Connect the network and power

You have two options for power and network connections. Your system administrator will advise you which one to use.

- AC power (Optional)
- Power over Ethernet (PoE)

### AC Power (Optional)

#### To connect the AC power:

1. Connect the DC plug on the power adapter to the DC5V port on the phone and connect the other end of the power adapter into an electrical power outlet.
2. Connect the included or a standard Ethernet cable between the Internet port on the phone and the one on the wall or switch/hub device port.

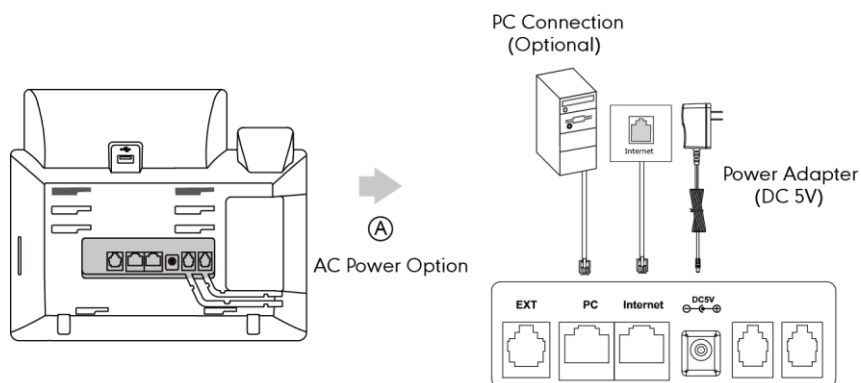

## Power over Ethernet

With the included or a regular Ethernet cable, the SIP-T48G IP phone can be powered from a PoE-compliant switch or hub.

### To connect the PoE:

1. Connect the Ethernet cable between the Internet port on the phone and an available port on the in-line power switch/hub.

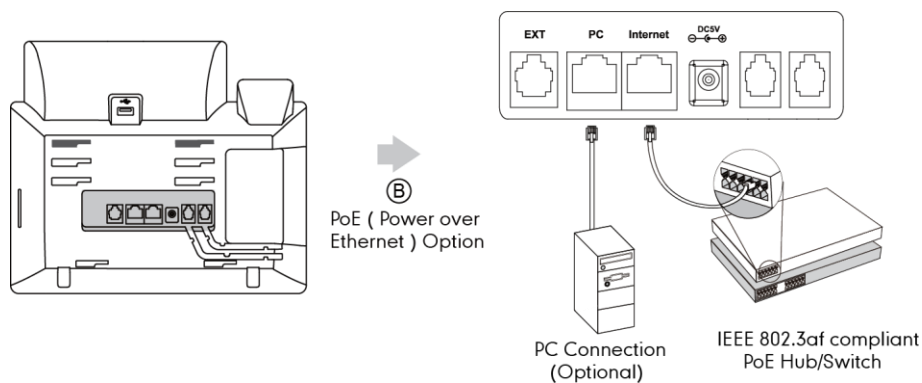

### Note

If in-line power switch/hub is provided, you don't need to connect the phone to the power adapter. Make sure the switch/hub is PoE-compliant.

The phone can also share the network with another network device such as a PC (personal computer). It is an optional connection.

**Important!** Do not unplug or remove power to the phone while it is updating firmware and configurations.

## Phone Initialization

After your phone is powered on, the system boots up and performs the following steps:

### Automatic Phone Initialization

The phone finishes the initialization by loading the saved configuration. The touch screen displays "Initializing...Please wait" during the initialization.

### DHCP (Dynamic Host Configuration Protocol)

The phone attempts to contact a DHCP server in your network to obtain valid IPv4 network settings (e.g., IP address, subnet mask, default gateway address and DNS address) by default.

### Note

If your network does not use DHCP, proceed to [Basic Network Settings](#) on page 19.

## Registration

Generally, your phone will be deployed with multiple other phones. In this case, your system administrator will configure the phone parameters beforehand, so that after you start up your phone, the phone will be registered and ready for use. If your phone is not registered, you may have to register it. For more information on how to register your phone, refer to [Account Management](#) on page 75.



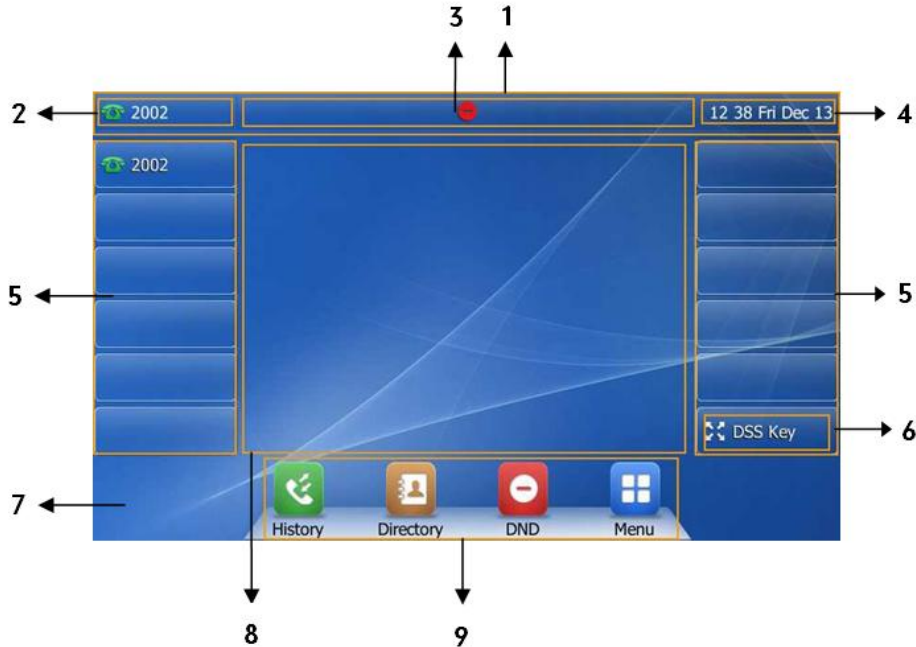

## Touch Screen Display

### Idle Screen Display

If the phone has successfully started up, the idle screen will be shown. The following figure is an example of what is displayed on the touch screen.



No.	Name	Description
1	Status Bar	Displays the phone's default account, icons and the time and date.
2	Default Account	The label of the default account is displayed on the left of the status bar.
3	Icons	Icons are displayed in the center of the status bar.
4	Time and Date	The phone's time and date are displayed on the right of the status bar.
5	Line Keys (1-11)	The idle screen displays line keys 1-11 and the line keys 1-6 on the left can be used to activate

No.	Name	Description
		up to six lines. Various features can be assigned to line keys. Each line key can show the label and indicate status of the assigned feature.
6	DSS Key	Provides a quick access to the line key configuration screen.
7	Wallpaper	Shows the specified wallpaper. You can customize the wallpaper. For more information, refer to <a href="#">Wallpaper</a> on page 23.
8	Call Window	Displays the call information.
9	Shortcut Keys	 : tap this shortcut key to enter the History screen and view call history.  : tap this shortcut key to enter the Directory screen and view contacts.  : tap this shortcut key to toggle the DND mode or enter the custom DND configuration screen.  : tap this shortcut key to enter the main menu.

### Configuration Screen Display

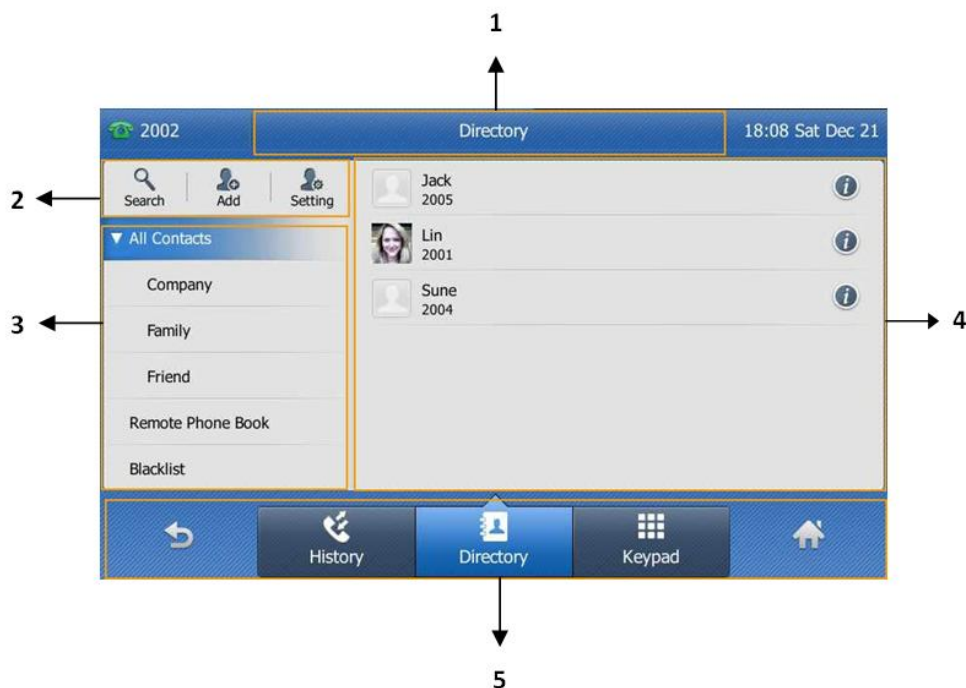

No.	Name	Description
1	Screen Title Area	Displays the title of the access menu screen.
2	Operation Option Area	Displays various operation options for different menu screens.
3	Menu Tree Area	Displays menu items. You can tap the desired menu item to enter the corresponding feature configuration screen.
4	Configuration Area	Displays configuration items of the highlighted menu item in the menu tree area. You can configure feature settings in this area.
5	Soft Keys	Label automatically to identify their context-sensitive features.

## Navigating Menus and Fields













To navigate menus and fields, you can:



- Tap soft keys on the touch screen.
- Tap menu items, fields, and arrows on the touch screen.
- Press keys on the phone keypad.

### Note

The menu system will automatically exit to the idle screen after 60 seconds of inactivity.

To operate your phone, follow these tips:

If you want to	Action
Enter the main menu.	Tap  .
Return to the idle screen.	Tap  .
Go back to the previous menu.	Tap  or press  .
Select an item.	Tap the item. Scroll to the item by pressing  or  .
Scroll through items page by page.	Tap  or  . (If you are in the call history, recent call list, language configuration screen or ring tones configuration screen, you can also press  or  .)
Scroll through values for a field.	Tap the field's highlighted gray box. From the pull-down list, tap  or  to scroll through









	values page by page, or press  or  to scroll values one by one.
Select a value for a field.	From the pull-down list, tap the value or scroll to the value and then press  .

## Entering Data and Editing Fields

You can enter data and edit fields using the keypad on the phone:

### To enter or edit data:

1. Tap the field.
2. Do one of the following:

If you want to	Action
Enter only numbers (1), uppercase (A) characters, lowercase (a) characters, or alphanumeric (2aB) characters.	<p>Press a digit key one or more times to enter the characters (in either lowercase or uppercase mode) or number that displays on the digit key.</p> <p>You can tap the <b>IME</b> soft key one or more times to switch between uppercase (<b>ABC</b> soft key), numeric (<b>123</b> soft key), alphanumeric (<b>2aB</b> soft key), title case (<b>Abc</b> soft key) and lowercase (<b>abc</b> soft key) input modes.</p> <p>For example, if the input mode is <b>ABC</b>:</p> <ul style="list-style-type: none"> <li>- To enter "A", press  once.</li> <li>- To enter "B", press  two times quickly.</li> <li>- To enter "C", press  three times quickly.</li> </ul>
Enter special characters.	Press the digit key  ,  or  . (These keys provide a different set of special characters.)
Delete text you entered.	Press  or  to position the cursor to the right of the text you want to delete, and then tap the <b>Delete</b> soft key.
Delete an entire field of data.	Double tap the field of data, so that the data is highlighted, and then tap the <b>Delete</b> soft key.

3. Press  or tap the **Save** soft key.

### Note

When the phone is in the pre-dialing screen, you can enter characters using the on-screen keypad.

## Phone Status

You can view phone status via phone user interface or web user interface.



Available information of phone status includes:

- General information (IP address, MAC address and firmware version)
- Network status (e.g., IPv4 status, IPv6 status, IP address mode and MAC address)
- Phone status (e.g., device model, hardware version, product ID and device certificate status)
- Account status (e.g., register status of SIP accounts)

### Note

You can view the device certificate status via phone user interface only.

**To view the phone status via phone user interface:**

1. Press , or tap  -> **Status**.



2. Tap the desired item to view the specific information.

**To view the phone status via web user interface:**

1. Open the web browser on your computer.
2. Enter the IP address in the browser's address bar, and then press the **Enter** key.



- Enter the user name (admin) and password (admin) in the login page.

- Click **Confirm** to login.

The phone status is displayed on the first page of the web user interface.

Section	Item	Value
Version	Firmware Version	35.72.0.1
	Hardware Version	35.0.0.0.0.0.0
Network	Internet Port	IPv4
IPv4	WAN Port Type	DHCP
	WAN IP Address	10.3.6.232
	Subnet Mask	255.255.255.0
	Gateway	10.3.6.254
	Primary DNS	192.168.1.167
	Secondary DNS	192.168.1.166
Network Common	MAC Address	00156551d7a9
	Link Status	Connected
	Device Type	Bridge
Account Status	Account1	2002@10.2.1.199 : Registered
	Account2	Disabled
	Account3	Disabled
	Account4	Disabled
	Account5	Disabled
	Account6	Disabled

**NOTE**

**Version**  
It shows the version of firmware.

**Network**  
It shows the information of WAN port.

## Basic Network Settings

If your phone cannot contact a DHCP server for any reason, you need to configure network settings manually. The IP phone can support either or both IPv4 and IPv6 addresses.

**To configure the IP address mode via phone user interface:**

- Tap  -> **Advanced** (password: admin) -> **Network**->**WAN Port**.
- Tap the gray box of the **IP Mode** field.

3. Tap the desired value (IPv4, IPv6 or IPv4 & IPv6) from the pull-down list.

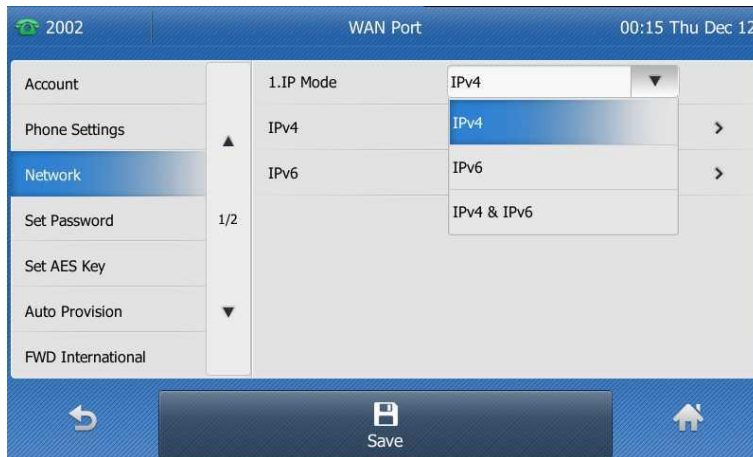

4. Tap the **Save** soft key to accept the change or to cancel.

**To configure a static IPv4 address via phone user interface:**

1. Tap ->**Advanced** (password: admin) ->**Network**->**WAN Port**->**IPv4**.
2. Tap the gray box of the **Type** field.
3. Tap **Static IP** from the pull-down list.
4. Enter the desired values in the **IP Address**, **Subnet Mask**, **Gateway**, **Primary DNS** and **Secondary DNS** fields respectively.

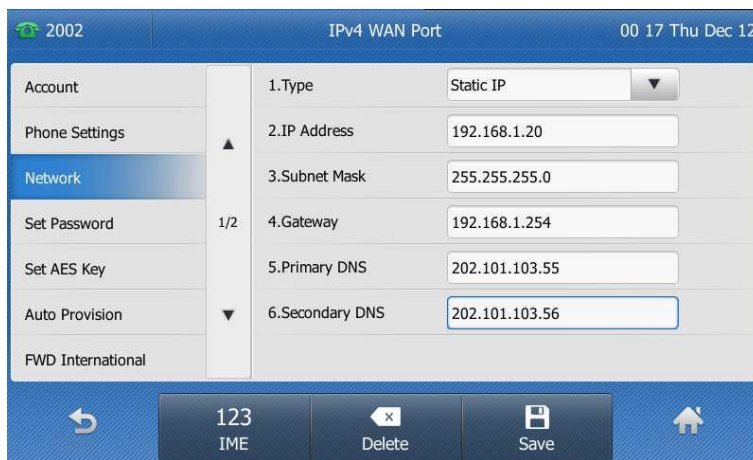

5. Tap the **Save** soft key to accept the change or to cancel.

**To configure a static IPv6 address via phone user interface:**

1. Tap ->**Advanced** (password: admin) ->**Network**->**WAN Port**->**IPv6**.
2. Tap the gray box of the **Type** field.
3. Tap **Static IP** from the pull-down list.

4. Enter the desired values in the **IP Address**, **IPv6 IP Prefix**, **Gateway**, **Primary DNS** and **Secondary DNS** fields respectively.

5. Tap the **Save** soft key to accept the change or to cancel.

If you are using an xDSL modem, you can connect your phone to the Internet via PPPoE mode. Set the WAN port as a PPPoE port. The PPPoE port will perform a PPP negotiation to obtain the IP address. Contact your system administrator for the PPPoE user name and password.

#### To configure PPPoE via phone user interface:

1. Tap ->**Advanced** (password: admin) ->**Network**->**WAN Port**->**IPv4**.
2. Tap the gray box of the **Type** field.
3. Tap **PPPoE** from the pull-down list.
4. Enter the PPPoE user name and password in the corresponding fields.

5. Tap the **Save** soft key to accept the change or to cancel.

#### Note

Wrong network settings may result in inaccessibility of your phone and may also have an impact on your network performance. For more information on these parameters, contact your system administrator.



# Customizing Your Phone

---

You can customize your SIP-T48G IP phone by personally configuring certain settings, for example, wallpaper, time & date and ring tones. You can add contacts to the phone's local directory manually or from the call history. You can also personalize different ring tones for different callers.

This chapter provides basic operating instructions for customizing your phone. Topics include:

- [General Settings](#)
- [Audio Settings](#)
- [Contact Management](#)
- [Call History Management](#)
- [System Customizations](#)

If you require additional information or assistance with your new phone, contact your system administrator.

## General Settings

### Wallpaper

You can customize the wallpaper of the SIP-T48G IP phone. You can change the wallpaper image via phone user interface or web user interface. You can also upload custom wallpaper images via web user interface. The file format of wallpaper image must be \*.jpg, \*.png or \*.bmp. A single file size must be less than 5M. and the total size of all custom wallpaper must be within 20M.

**To change the wallpaper via phone user interface:**

1. Tap  -> **Basic->Display->Wallpaper.**

2. Tap ◀ or ▶, or press ◀ or ▶ to select the desired wallpaper image.



3. Tap the **Save** soft key to accept the change or ↶ to cancel.

Wallpaper is configurable via web user interface at the path **Settings->Preference**.

To upload the custom wallpaper via web user interface:

1. Click on **Settings->Preference**.
2. In the **Upload Wallpaper (800\*480)** field, click **Browse** to locate the wallpaper image from your local system.

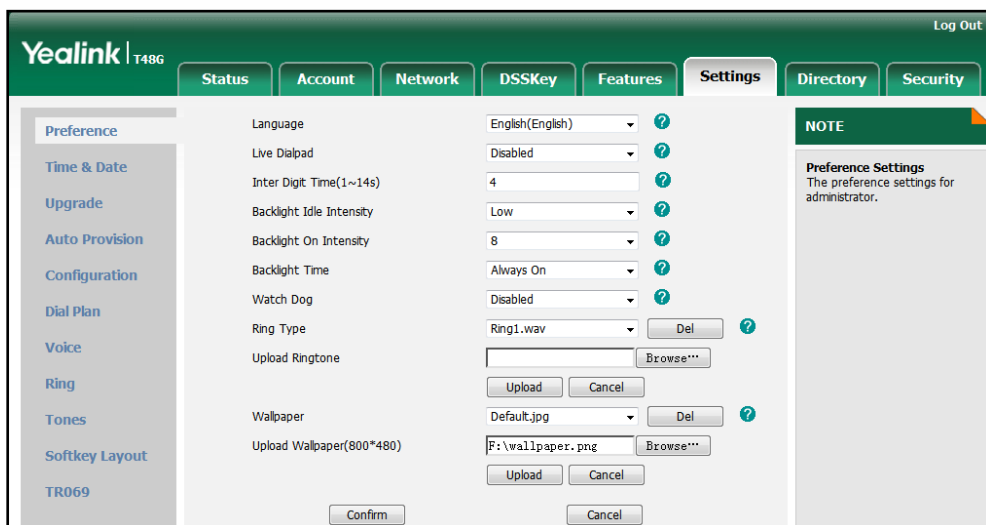

3. Click **Upload** to upload the file.
4. Click **Confirm** to accept the change.

The custom wallpaper appears in the pull-down list of **Wallpaper**.

## Backlight

You can configure backlight to adjust the brightness of the touch screen. Backlight On Intensity is used to adjust the backlight intensity of the touch screen. Backlight time specifies the delay time to turn off or dusky the backlight when the IP phone is inactive.

Backlight Idle Intensity decides whether the IP phone turns off or dusky the backlight of the touch screen after a period of inactivity.

You can configure the backlight status on the touch screen as the following types:

- **Always On:** Backlight is on permanently.
- **15s, 30s, 60s, 120s, 300s, 600s, 1800s:** Backlight goes out or turns dusky when the phone has been inactive for approximately 15, 30, 60, 120, 300, 600 or 1800 seconds.

**To configure the backlight via phone user interface:**

1. Tap  -> **Basic**->**Display**->**Backlight**.
2. Tap the gray box of the **Backlight Active Level** field.
3. Tap the desired level from the pull-down list.
4. Tap the gray box of the **Backlight Inactive Level** field.
5. Tap the desired value from the pull-down list.
6. Tap the gray box of the **Backlight Time** field.
7. Tap the desired time from the pull-down list.



8. Tap the **Save** soft key to accept the change or  to cancel.

Backlight is configurable via web user interface at the path **Settings->Preference**.

## Contrast

You can configure the contrast of the expansion module EXP40 connected to the SIP-T48G IP phone to a comfortable level on the phone. Ensure that the expansion module has been connected to the phone before configuration.

**To configure the contrast via phone user interface:**

1. Tap  -> **Basic**->**Display**->**Contrast**.
2. Tap the gray box of the **Contrast Level** field.

3. Tap the desired value from the pull-down list.

The default contrast level is 6.



4. Tap the **Save** soft key to accept the change or  to cancel.

## Language

The default language of the phone user interface is English. The phone will detect and use the same language as which of your web browser for the web user interface. If the language of your web browser is not supported by the phone, the web user interface will use English by default. You can change the language for the phone user interface and the web user interface respectively.

### Note

Not all of the supported languages are available for selection. The available languages depend on the language packs currently loaded to the IP phone. Please contact your system administrator for more information on the available languages of your new phone.

**To change the language for the phone user interface:**

1. Tap  -> **Basic**->**Language**.



2. Tap the desired language.



3. Tap the **Save** soft key to accept the change.

Text displayed on the phone user interface will change to the selected language.

**To change the language for the web user interface:**

1. Click on **Settings->Preference**.
2. Select the desired language from the pull-down list of **Language**.

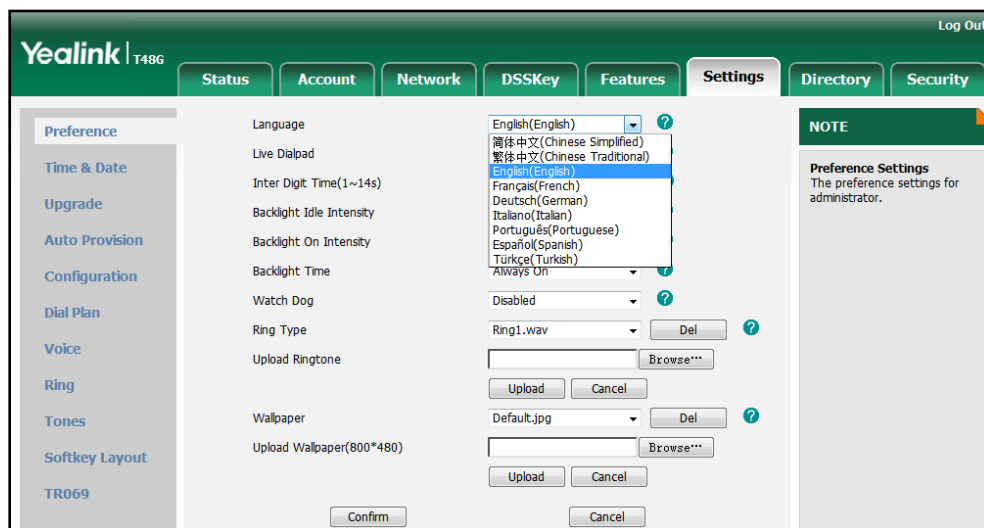

3. Click **Confirm** to accept the change.

Text displayed on the web user interface will change to the selected language.

## Time & Date

The time and date are displayed on the touch screen when the phone is idle. You can configure the phone to obtain the time and date from the SNTP server automatically, or configure the time and date manually. If the phone cannot obtain the time and date from the Simple Network Time Protocol (SNTP) server, contact your system administrator for more information.

**To configure the SNTP settings via phone user interface:**

1. Tap  -> **Basic**->**Time & Date**->**General**.
2. Tap the gray box of the **Type** field.
3. Tap **SNTP Settings** from the pull-down list.
4. Tap the gray box of the **Time Zone** field.
5. Tap the time zone that applies to your area from the pull-down list.  
The default time zone is "+8 China(Beijing)".
6. Enter the domain names or IP addresses of SNTP servers in the **NTP Server 1** and **NTP Server 2** fields respectively.
7. Tap the gray box of the **Daylight Saving** field.
8. Tap the desired value from the pull-down list.



9. Tap the **Save** soft key to accept the change or  to cancel.

**Note**

Please refer to [Appendix A - Time Zones](#) for the list of available time zones on the IP phone.

**To configure the time and date manually via phone user interface:**

1. Tap  -> **Basic**->**Time & Date**->**General**.
2. Tap the gray box of the **Type** field.
3. Tap **Manual Settings** from the pull-down list.

4. Enter the specific date and time in the corresponding fields.



5. Tap the **Save** soft key to accept the change.

The time and date displayed on the touch screen will change accordingly.

There are 7 available date formats. For example, for the date format “WWW DD MMM”, “WWW” represents the abbreviation of the week, “DD” represents the two-digit day, and “MMM” represents the first three letters of the month.

The date formats you need to know:

Date Format	Example (2013-7-27)
WWW MMM DD	Sat Jul 27
DD-MMM-YY	27-Jul-13
YYYY-MM-DD	2013-07-27
DD/MM/YYYY	27/07/2013
MM/DD/YY	07/27/13
DD MMM YYYY	27 Jul 2013
WWW DD MMM	Sat 27 Jul

**To configure the date and time format via phone user interface:**

1. Tap  -> **Basic**->**Time & Date**->**Format**.
2. Tap the gray box of the **Date Format** field.
3. Tap the desired date format from the pull-down list.
4. Tap the gray box of the **Time Format** field.

5. Tap the desired time format (12 Hour or 24 Hour) from the pull-down list.

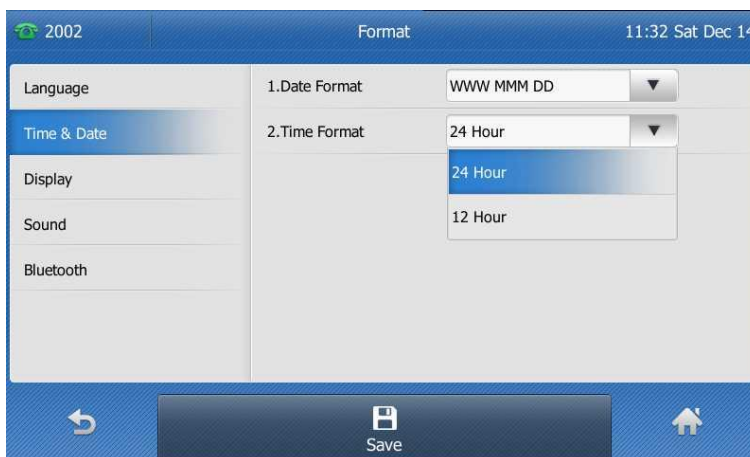

6. Tap the **Save** soft key to accept the change or  to cancel.

Time and date are configurable via web user interface at the path **Settings->Time & Date**.

## Administrator Password

The Advanced option is only accessible to the administrator. The default administrator password is "admin". For security reasons, you should change the default administrator password as soon as possible.

**To change the administrator password via phone user interface:**

1. Tap  ->**Advanced** (password: admin) ->**Set Password**.
2. Enter the old password in the **Current Password** field.
3. Enter the new password in the **New Password** field.
4. Enter the new password again in the **Confirm Password** field.

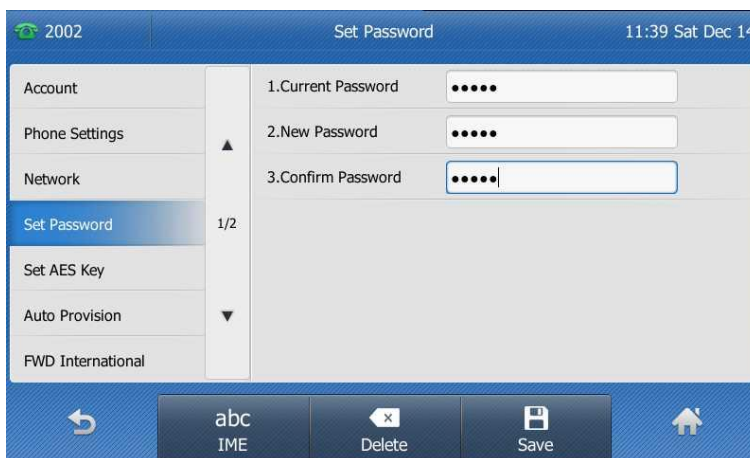

5. Tap the **Save** soft key to accept the change or  to cancel.

Administrator password is configurable via web user interface at the path **Security->Password**.

## Key as Send

You can set the "#" or "\*" to perform as a send key while dialing.

To configure key as send via phone user interface:

1. Tap  -> **Call Features**->**General**.
2. Tap the gray box of the **Key as Send** field.
3. Tap # or \* from the pull-down list, or tap **Disabled** to disable this feature.

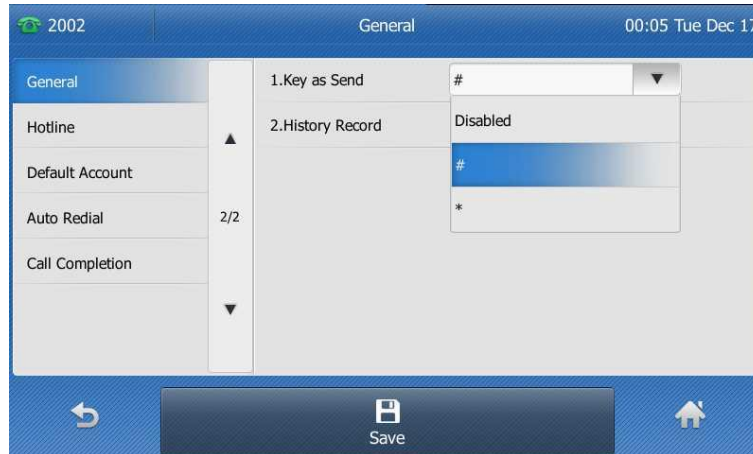

4. Tap the **Save** soft key to accept the change or  to cancel.

Key as send is configurable via web user interface at the path **Features->General Information**.

## Audio Settings

### Volume

You can press the volume key to adjust the ringer volume when the phone is idle. You can also press the volume key to adjust the receiver volume of currently engaged audio devices (handset, speakerphone or headset) when the phone is in use.

**To adjust the volume when the phone is idle:**

1. Press  to adjust the ringer volume.



**Note** If ringer volume is adjusted to minimum, the  icon will appear on the touch screen.

**To adjust the volume when the phone is during a call:**

1. Press  to adjust the volume of currently engaged audio device (handset, speakerphone or headset).



## Ring Tones

Ring tones are used to indicate incoming calls. You can select different ring tones to distinguish different accounts registered on your phone, or to distinguish your phone from your neighbor's.

**To select a ring tone for the phone via phone user interface:**

1. Tap  -> Basic->Sound->Ring Tones.

2. Tap the desired ring tone.



3. Tap the **Save** soft key to accept the change or  to cancel.

To select a ring tone for the account via web user interface:

1. Click on **Account**.
2. Select the desired account from the pull-down list of **Account**.
3. Click on **Basic**.
4. Select the desired ring tone from the pull-down list of **Ring Type**.

If **Common** is selected, this account will use the ring tone selected for the phone. Refer to the above instruction.

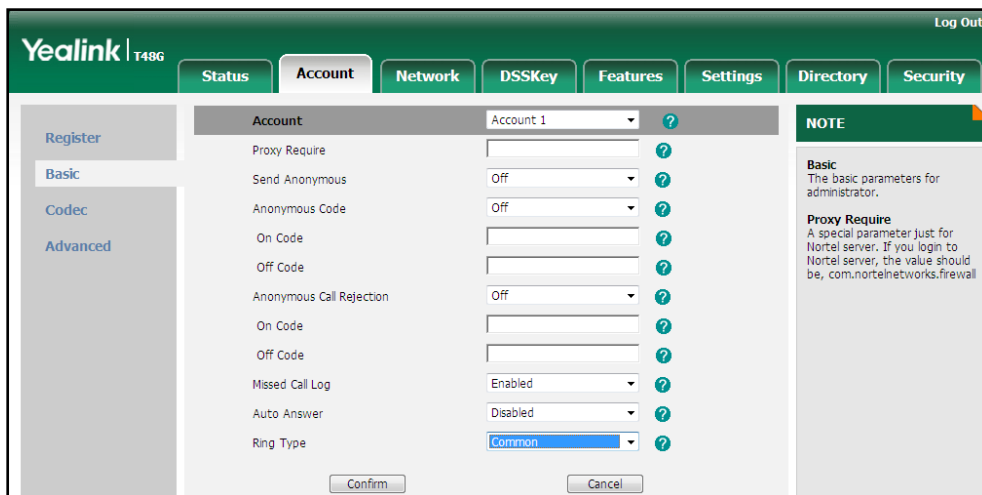

5. Click **Confirm** to accept the change.

**Note**

A ring tone for the account is configurable via web user interface only.

The ring tone for an incoming call on the phone may be different. For example, when the phone receives an incoming call from a contact stored in the local directory, it will play the ring tone assigned to the contact in the local directory (refer to [Adding Contacts](#)). If no ring tone is assigned to the contact, the phone will play the ring tone assigned to the associated group (refer to [Groups](#)). Otherwise, the phone will play the ring tone assigned to the account. If no ring tone is assigned to the contact, the associated group and account, the phone will play the ring tone assigned to the phone.



To upload a custom ring tone for your phone via web user interface:

1. Click on **Settings->Preference**.
2. In the **Upload Ringtone** field, click **Browse** to locate a ring tone file (the file format must be \*.wav) from your local system.

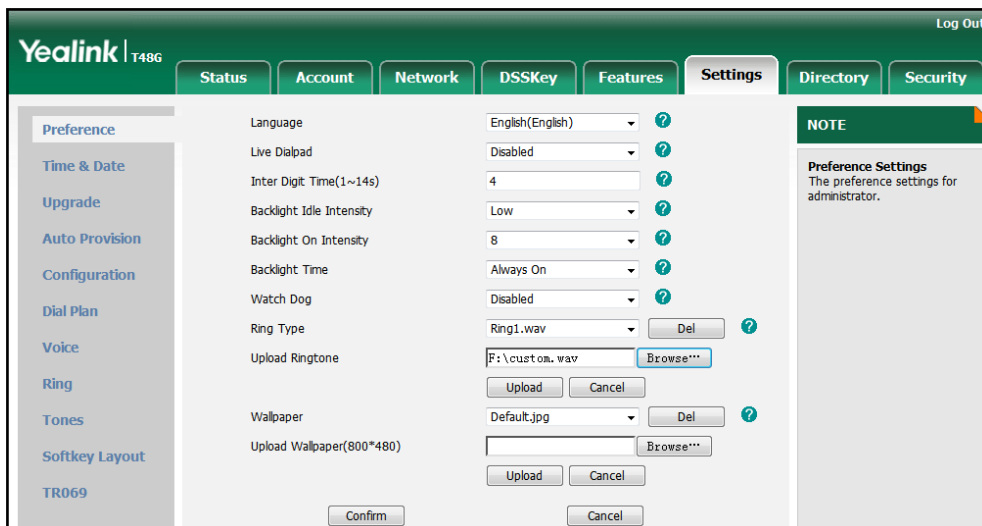

3. Click **Upload** to upload the file.

**Note** All custom ring tone files must be within 100KB. Uploading custom ring tones for your phone is configurable via web user interface only.

## Contact Management

This section provides the operating instructions for managing contacts. Topics include:

- [Directory](#)
- [Local Directory](#)
- [Blacklist](#)
- [Remote Phone Book](#)

## Directory

Directory provides easy access to frequently used lists. The lists may contain Local Directory, History, Remote Phone Book and LDAP.

To configure the directory via web user interface:

1. Click on **Directory->Setting**.
2. In the **Directory** block, select the desired list from the **Disabled** column and then click  .



The selected list appears in the **Enabled** column.

3. Repeat the step 2 to add more lists to the **Enabled** column.
4. To remove a list from the **Enabled** column, select the desired list and then click  .

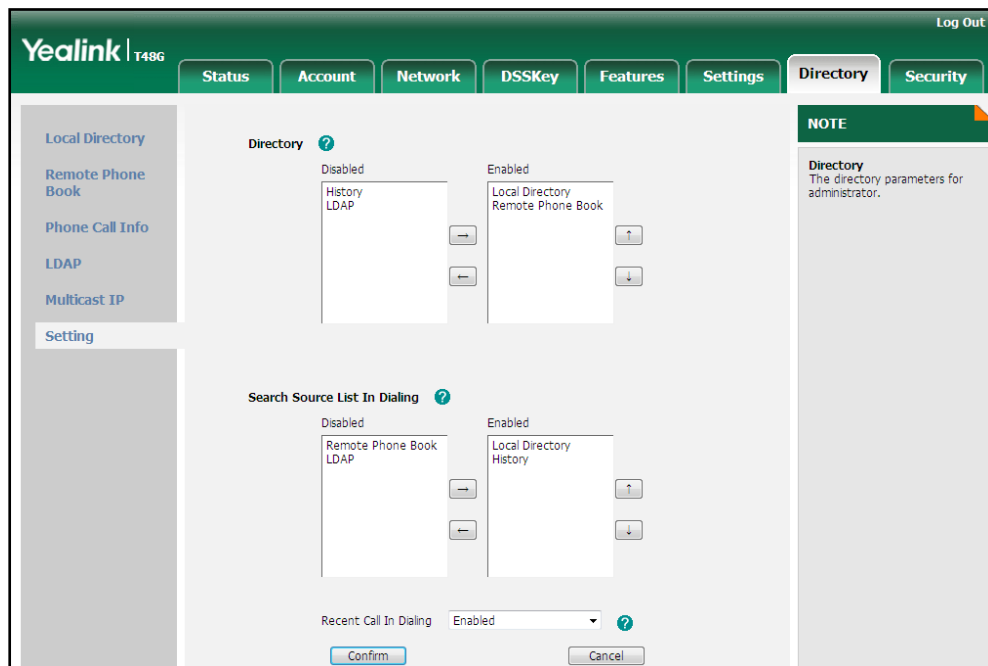



5. Click **Confirm** to accept the change.

### Note

Directory is configurable via web user interface only.

If the remote phone book and LDAP are not configured in advance, you cannot view remote phone book and LDAP lists on the phone user interface. For more information on remote phone book, refer to [Remote Phone Book](#) on page 53. For more information on LDAP, refer to *Yealink\_SIP-T4X\_IP\_Phone\_Family\_Administrator\_Guide\_V72\_2*.

### To check directory via phone user interface:

1. Tap  when the phone is idle.
  - If there is only one list is enabled for the directory, tap  to view the list directly.

- If more than one list is enabled for the directory, tap the desired list you want to view, and then tap the **OK** soft key.



## Local Directory



The built-in phone directory can store the names and phone numbers of your contacts. You can store up to 1000 contacts and 48 groups in your phone's local directory. There are three default groups in the local directory: Company, Family and Friend. You can add new groups and contacts; edit, delete or search for a contact; or simply dial a contact number from the local directory.

## Groups

To add a group to the local directory:

1. Tap .

The IP phone enters the local directory directly as there is only Local Directory in the directory by default.



If Local Directory is disabled for the directory, tap  -> **All Contacts** or tap  -> **Directory** -> **All Contacts** to enter the local directory.

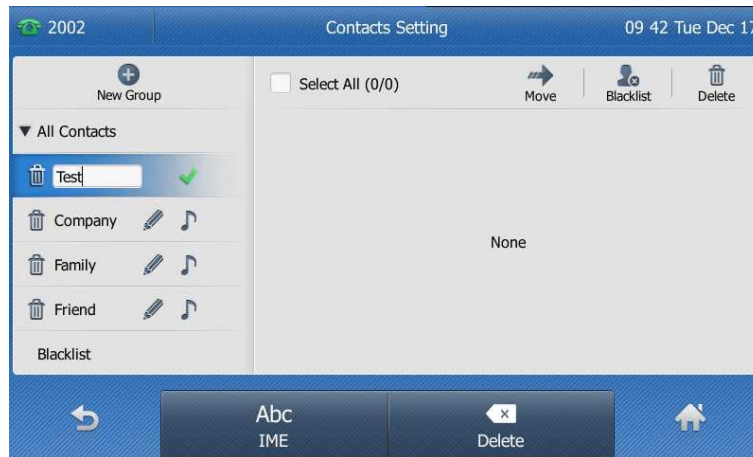

2. Tap **Setting**.

3. Tap **New Group**.
4. Enter the desired group name in the highlighted field.



5. Tap  to accept the change.
6. Tap  to specify a ring tone for the group.
7. Tap the desired ring tone.

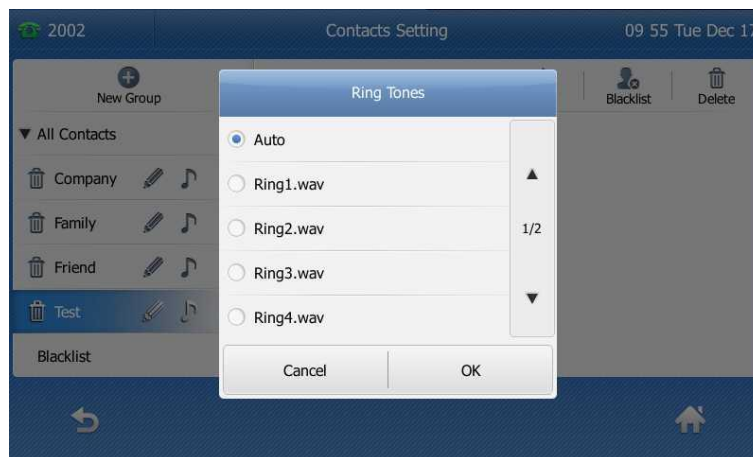

If **Auto** is selected, the contact in this group will use the ring tone specified to the contact. Otherwise, it then plays the ring tone specified to the account. For more information on the ring tone for the account, refer to [Ring Tones](#) on page 32.



8. Tap the **OK** soft key to accept the change.

You can also edit or delete the Company, Family, Friend and the new added contact groups.

**To edit a group in the local directory:**

1. Tap .

The IP phone enters the local directory directly as there is only Local Directory in the directory by default.

If Local Directory is disabled for the directory, tap  -> **All Contacts** or tap  -> **Directory** -> **All Contacts** to enter the local directory.

2. Tap **Setting**.
3. Tap the desired group.
4. Tap  after the group.

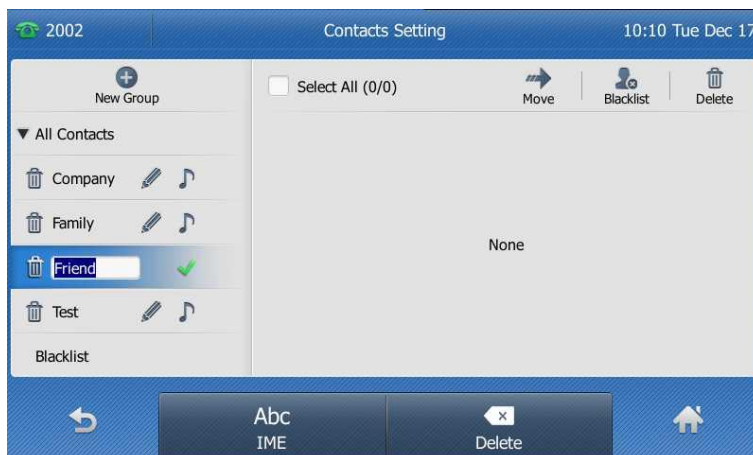



5. Edit the group name in the highlighted field.
6. Tap  to accept the change.

**To delete a group from the local directory:**

1. Tap .

The IP phone enters the local directory directly as there is only Local Directory in the directory by default.

If Local Directory is disabled for the directory, tap  -> **All Contacts** or tap  -> **Directory** -> **All Contacts** to enter the local directory.

2. Tap **Setting**.
3. Tap the desired group.
4. Tap  before the group.

The touch screen prompts the following warning:

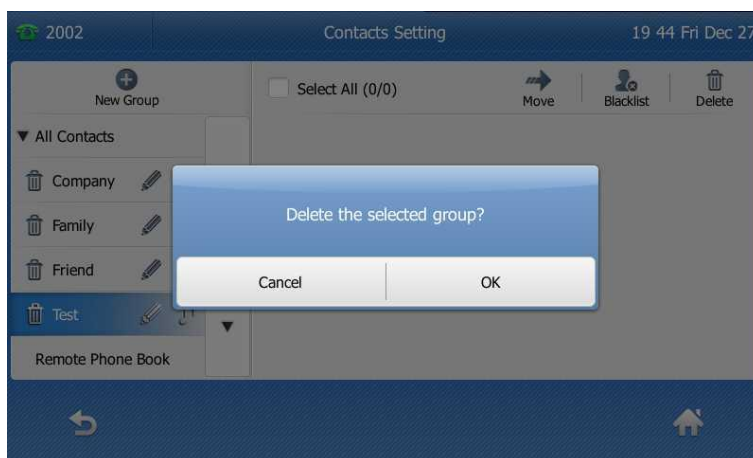

5. Tap the **OK** soft key to confirm the deletion or the **Cancel** soft key to cancel.

## Adding Contacts

You can add contacts to the local directory in the following ways:



- Manually
- From call history
- From remote phone book

### Adding Contacts Manually

To add a contact to the local directory manually:

1. Tap .

The IP phone enters the local directory directly as there is only Local Directory in the directory by default.

If Local Directory is disabled for the directory, tap  -> **All Contacts** or tap  -> **Directory** -> **All Contacts** to enter the local directory.

2. Tap the desired contact group.
3. Tap **Add**.
4. Enter the name and the office, mobile or other numbers in the corresponding fields.







5. Tap the gray box of the **Account** field.
6. Tap the desired account from the pull-down list.  
If **Auto** is selected, the phone will use the first available account when placing calls to the contact from the local directory.
7. Tap the gray box of the **Ring** field.
8. Tap the desired ring tone from the pull-down list.  
If **Auto** is selected, this contact will use the ring tone assigned to the group.
9. Tap the gray box of the **Photo** field.
10. Tap the desired photo from the pull-down list.

11. Tap the **Save** soft key to accept the change or  to cancel.

**Note** If the contact has existed in the directory, the touch screen will prompt "Contact name already existed!".

## Adding Contacts from Call History

To add a contact to the local directory from the call history:

1. Tap .
2. Tap  or  to turn pages.
3. Tap  after the desired entry.

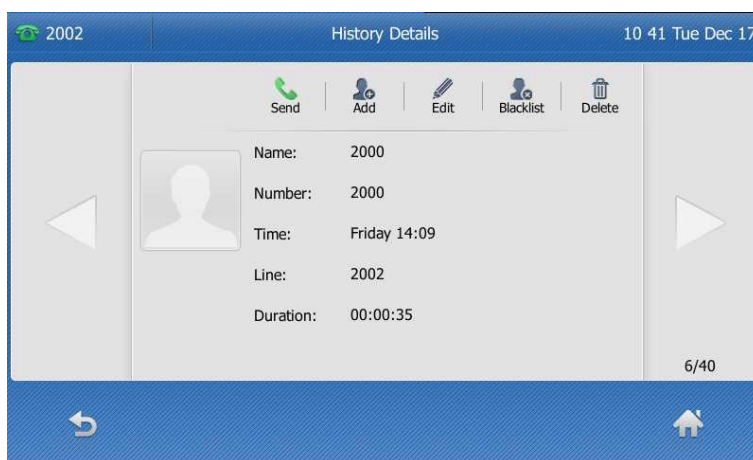

4. Tap **Add**.
5. Edit the corresponding fields.



6. Tap the **Save** soft key to accept the change.  
The entry is successfully saved to the local directory.

## Adding Contacts from remote phone book

To add a contact to the local directory from remote phone book:

1. Tap .

The IP phone enters the local directory directly as there is only Local Directory in the directory by default.

2. Tap **Remote Phone Book**.

If Remote Phone Book is disabled for the directory, tap  -> **Directory** -> **Remote Phone Book** to enter the remote phone book.



3. Tap the desired remote phone book.

The phone connects to load the corporate directory, and then displays corporate contacts on the touch screen.

4. Tap  after the desired corporate contact.

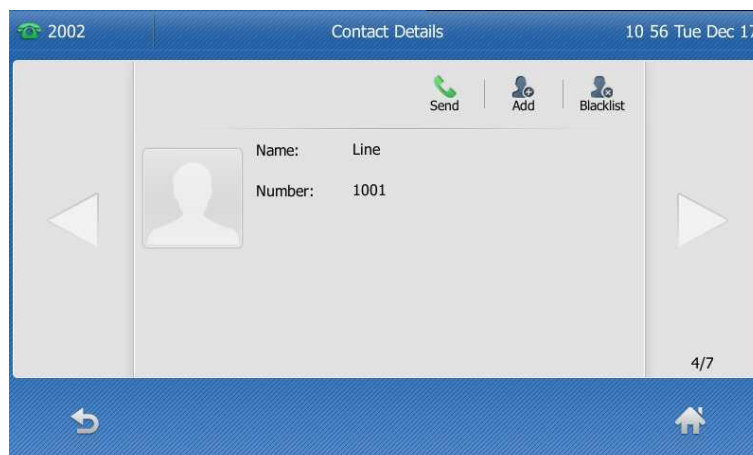

5. Tap **Add**.



6. Edit the corresponding fields.

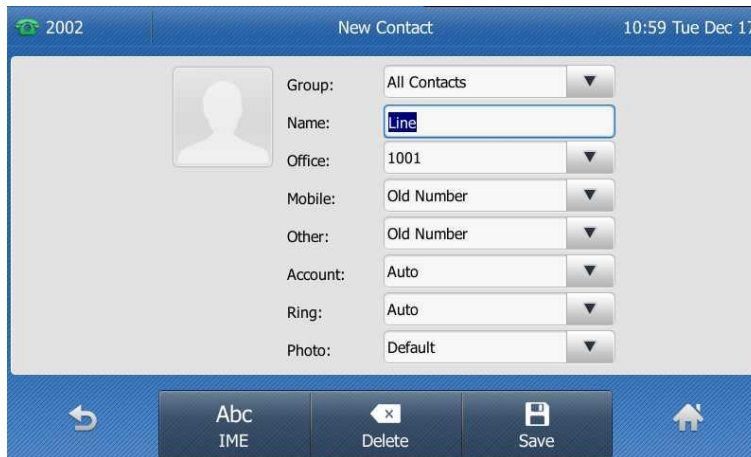

7. Tap the **Save** soft key to save the contact to the local directory.

If the contact has already existed in the local directory, the touch screen will prompt "Overwrite the original contact?". Tap the **OK** soft key to overwrite the original contact in the local directory or the **Cancel** soft key to cancel.



For more information on remote phone book operation, refer to [Remote Phone Book](#) on page 53.

## Editing Contacts

**To edit a contact in the local directory:**

1. Tap .

The IP phone enters the local directory directly as there is only Local Directory in the directory by default.

If Local Directory is disabled for the directory, tap  -> **All Contacts** or tap  -> **Directory** -> **All Contacts** to enter the local directory.

2. Tap  after the desired contact.
3. Tap the desired field to edit the contact information.

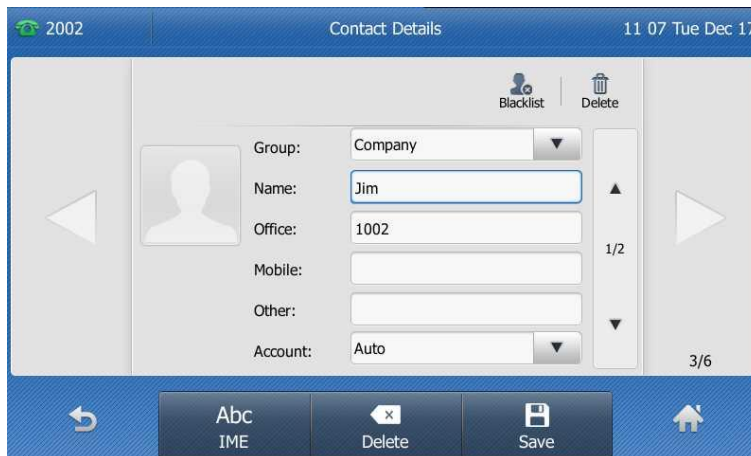

You can tap  or  to switch the contact you want to edit.





4. Tap the **Save** soft key to accept the change or  to cancel.

## Deleting Contacts

**To delete a contact from the local directory:**

1. Tap .

The IP phone enters the local directory directly as there is only Local Directory in the directory by default.

If Local Directory is disabled for the directory, tap  -> **All Contacts** or tap  -> **Directory** -> **All Contacts** to enter the local directory.



2. Tap  after the desired contact.
3. Tap **Delete**.

The touch screen prompts the following warning:

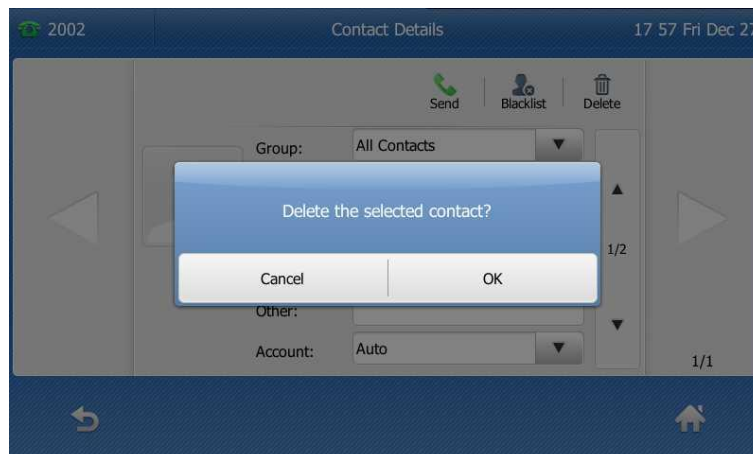



4. Tap the **OK** soft key to confirm the deletion or the **Cancel** soft key to cancel.

**To delete all contacts:**

1. Tap .

The IP phone enters the local directory directly as there is only Local Directory in the directory by default.

If Local Directory is disabled for the directory, tap  -> **All Contacts** or tap  -> **Directory** -> **All Contacts** to enter the local directory.



2. Tap **Setting**.
3. Tap the checkbox of **Select All**.
4. Tap **Delete**.

The touch screen prompts the following warning:

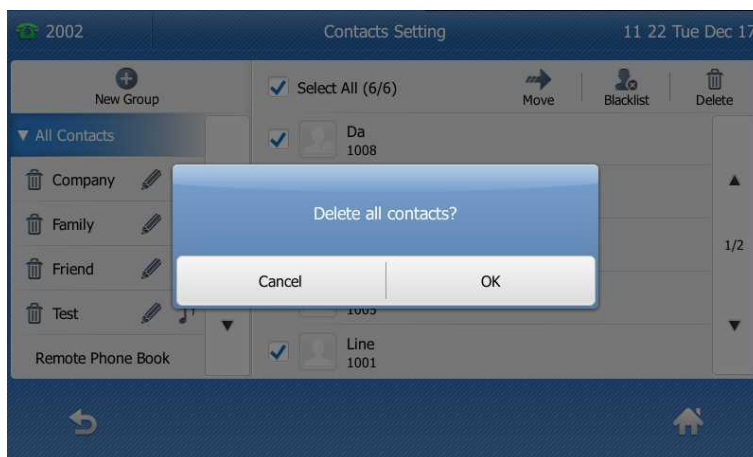

5. Tap the **OK** soft key to confirm the deletion or the **Cancel** soft key to cancel.

## Uploading Contact Photos

To upload a new custom photo for a contact via web user interface:

1. Click on **Directory**->**Local Directory**.
2. Click **Browse**, and then locate a photo file from your local computer.

3. Click **Upload Photo** to upload the photo.

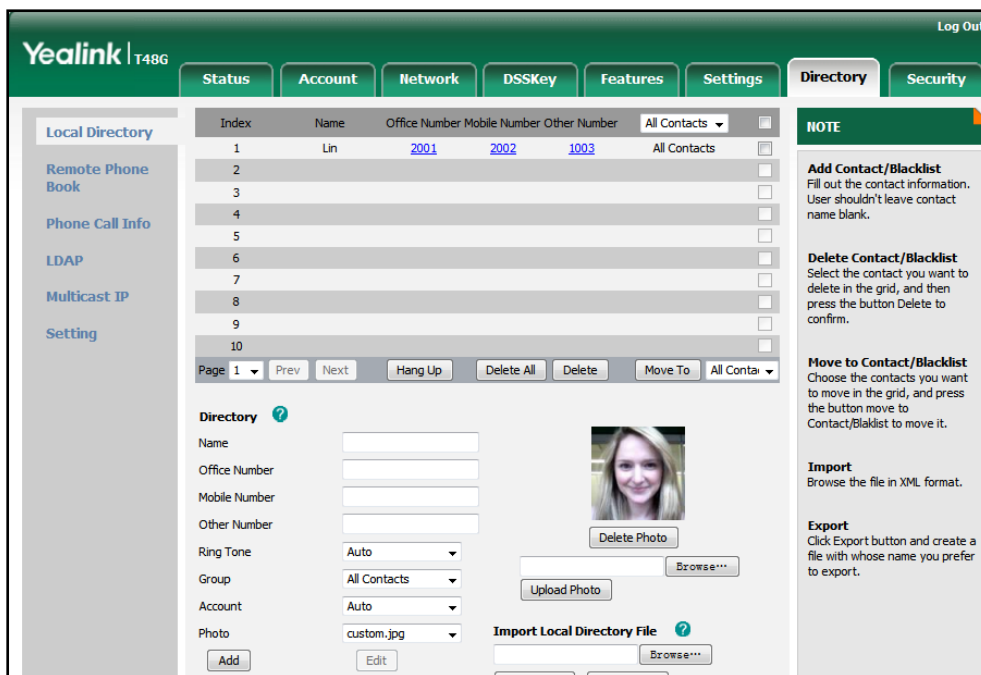

You can click **Delete Photo** to delete the custom photo.

**Note**

The phone only supports the \*.png, \*.jpg and .bmp format files. The file size must be less than 5M.

You can only delete the custom photo.

**To change the custom photo for the contact via web user interface:**

1. Click on **Directory->Local Directory**.
2. Click the desired entry you want to edit.
3. Select the desired photo from the pull-down list of **Photo**.
4. Click **Edit** to accept the change.

When you place a call to the contact or receive a call from the contact, the touch screen will display the contact photo.





## Placing Calls to Contacts

To place a call to a contact from the local directory:

1. Tap .

The IP phone enters the local directory directly as there is only Local Directory in the directory by default.

If Local Directory is disabled for the directory, tap  -> **All Contacts** or tap  -> **Directory** -> **All Contacts** to enter the local directory.



2. Tap the desired contact.

- If only one number of the contact is stored in the local directory, the contact number will be dialed out.
- If multiple numbers of the contact are stored in the local directory, the touch screen will prompt:



Tap the desired number.



The tapped number is dialed out.

## Searching for Contacts

To search for a contact in the local directory:

1. Tap .

The IP phone enters the local directory directly as there is only Local Directory in the directory by default.

If Local Directory is disabled for the directory, tap  -> **All Contacts** or tap  -> **Directory** -> **All Contacts** to enter the local directory.

2. Tap **Search**.
3. Enter a few continuous characters of the contact name or the contact number using the keypad.



The contacts whose name or phone number matches the characters entered will appear on the touch screen. You can dial from the result list.

## Search Source List in Dialing



You can search for a contact from the desired lists when the phone is in the pre-dialing screen. The lists can be Local Directory, History, Remote Phone Book and LDAP.

To configure search source list in dialing via web user interface:

1. Click on **Directory**->**Setting**.
2. In the **Search Source List In Dialing** block, select the desired list from the **Disabled** column and click .

The selected list appears in the **Enabled** column.

3. Repeat step 2 to add more lists to the **Enabled** column.
4. (Optional.) To remove a list from the **Enabled** column, select the desired list and then click .

- To adjust the display order of the enabled list, select the desired list, and click  or  .

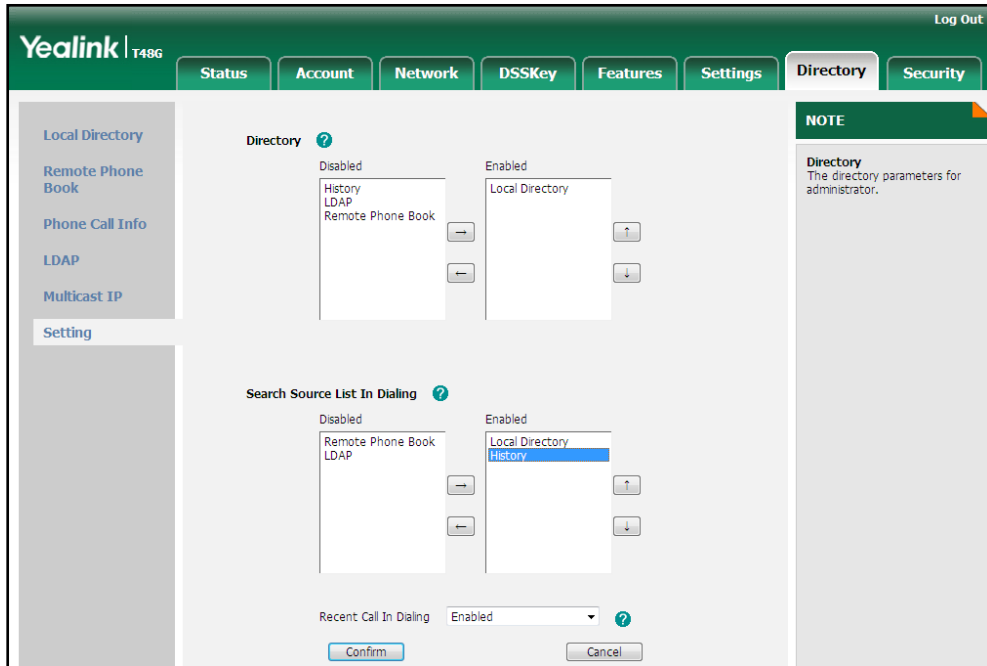

- Click **Confirm** to accept the change.  
The touch screen will display the search results in the adjusted order.

**Note** Search source list in dialing is configurable via web user interface only.

**To search for an entry in the enabled search source lists:**

- Pick up the handset, press the speakerphone key or tap the line key.
- Enter a few continuous characters of the entry's name or the entry's phone number.  
The entries in the enabled search source lists whose name or phone number matches the characters entered will appear on the touch screen.  
You can tap the desired entry to place a call to the entry.



## Importing/Exporting Contact Lists

You can manage your phone's local directory via phone user interface or web user interface. But you can only import or export the contact list via web user interface.

**To import an XML file of contact list via web user interface:**

1. Click on **Directory->Local Directory**.
2. Click **Browse** to locate a contact list file (file format must be \*.xml) from your local system.

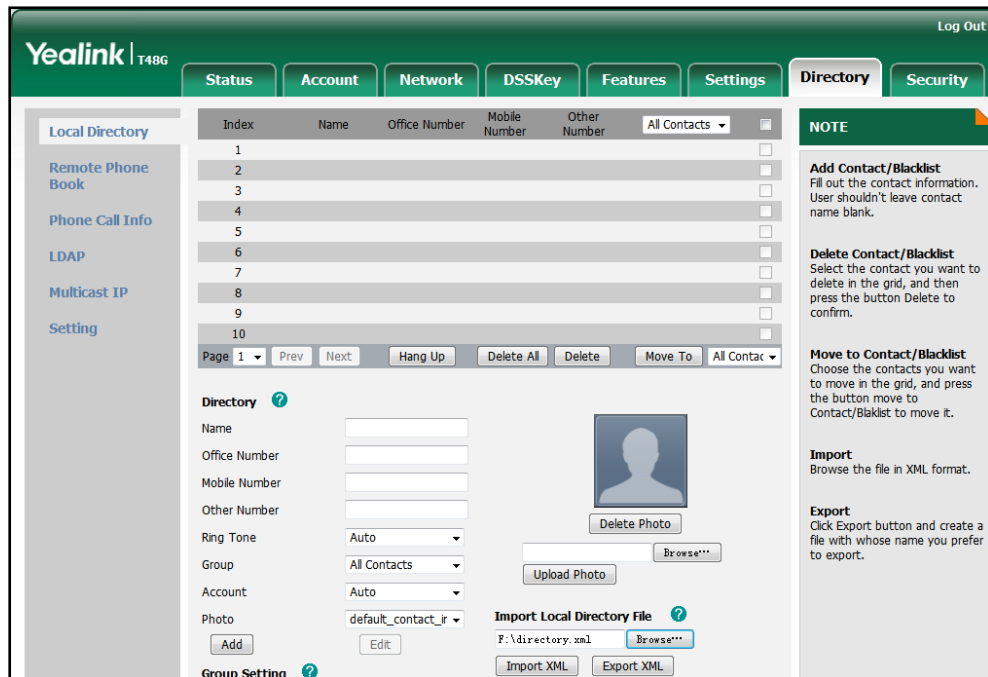

3. Click **Import XML** to import the contact list.  
The web user interface prompts "The original contact will be covered, Continue?".
4. Click **OK** to complete importing the contact list.

**To import a CSV file of contact list via web user interface:**

1. Click on **Directory->Local Directory**.
2. Click **Browse** to locate a contact list file (file format must be \*.csv) from your local system.
3. (Optional.) Check the **Show Title** checkbox.



It will prevent importing the title of the contact information which is located in the first line of the CSV file.

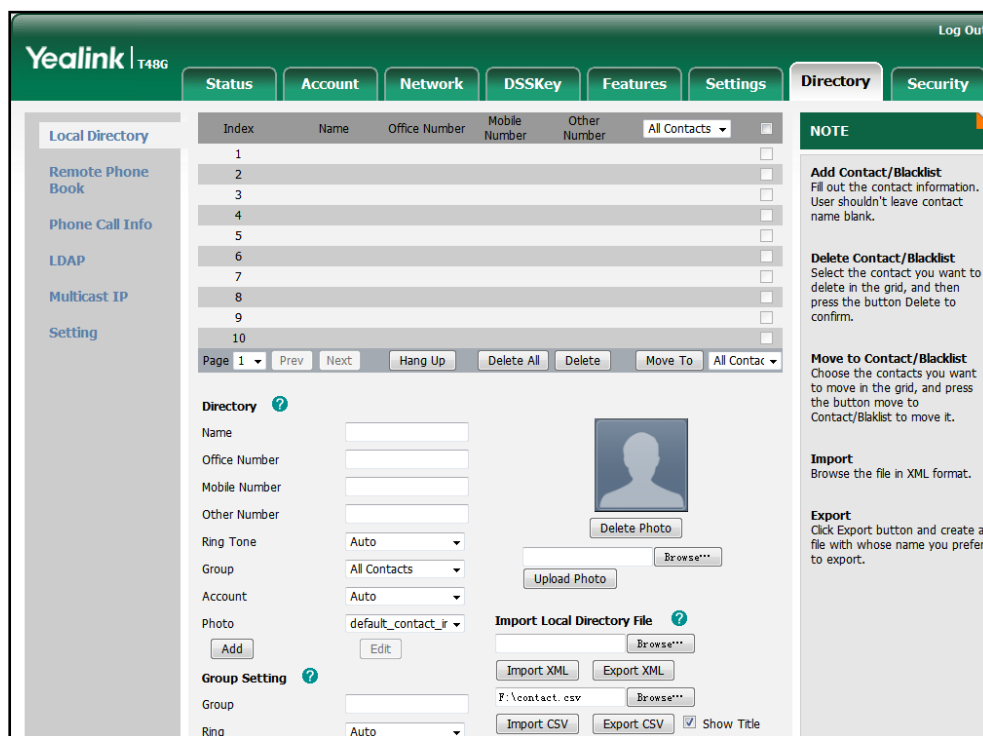

4. Click **Import CSV** to import the contact list.
5. (Optional.) Mark the **On** radio box in the **Delete Old Contacts** field.  
It will delete all existing contacts while importing the contact list.
6. (Optional.) Select the contact information you want to import into the local directory from the pull-down list of **Index**.

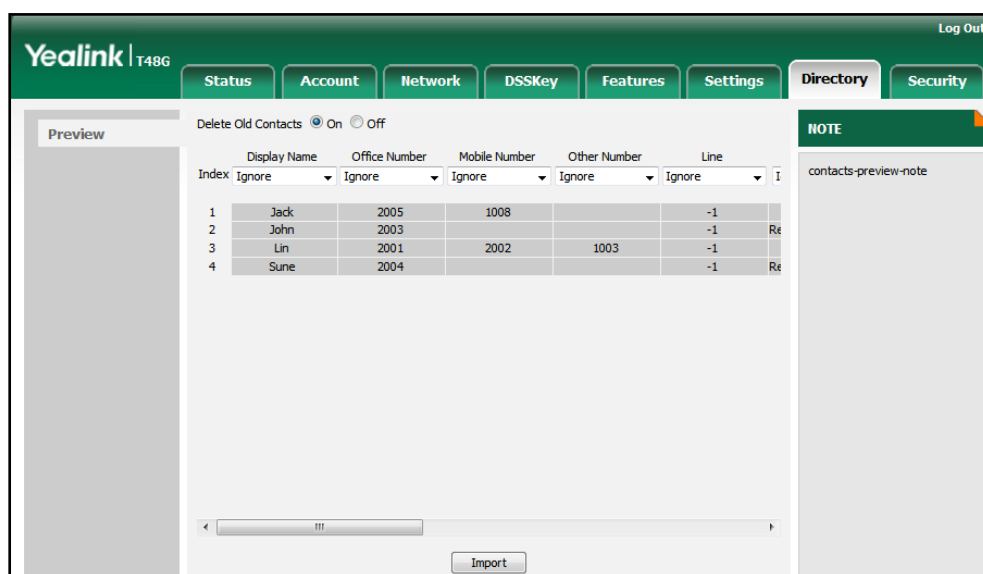

7. Click **Import** to complete importing the contact list.



**To export a contact list via web user interface:**

1. Click on **Directory**->**Local Directory**.
2. Click **Export XML** (or **Export CSV**).
3. Click **Save** to save the contact list to your local system.

**Note**

Importing/exporting contact lists is available via web user interface only.

## Blacklist

The built-in phone directory can store the names and phone numbers for a blacklist. You can store up to 30 contacts; add, edit, delete or search for a contact in the blacklist directory; even call a contact from the blacklist directory, but incoming calls from the blacklist directory contacts will be rejected automatically.

**To add a contact to the blacklist directory manually:**

1. Tap .

The IP phone enters the local directory directly as there is only Local Directory in the directory by default.

2. Tap **Blacklist**.

If Local Directory is disabled for the directory, tap  ->**Directory** ->**Blacklist** to enter the blacklist directory.





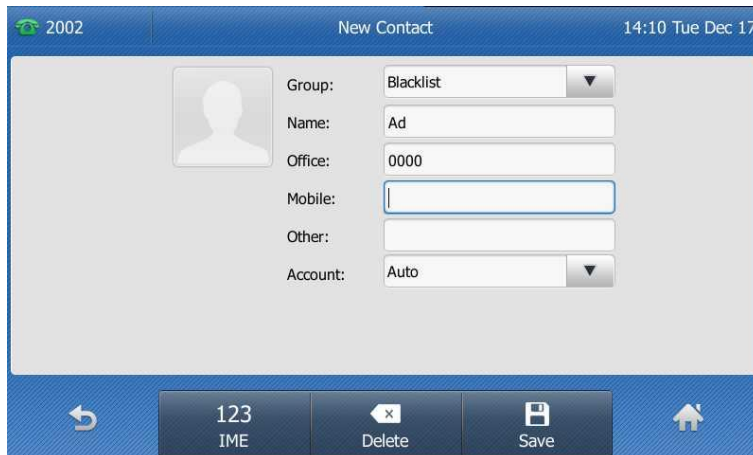

3. Tap **Add**.

- Enter the name and the office, mobile or other numbers in the corresponding fields.



- Tap the gray box of the **Account** field.
- Tap the desired account from the pull-down list.  
If **Auto** is selected, the phone will use the first available account when placing calls to the contact from the blacklist directory.
- Tap the **Save** soft key to accept the change or ↶ to cancel.

**To add a contact to the blacklist directory from the local directory:**

- Tap .  
The IP phone enters the local directory directly as there is only Local Directory in the directory by default.  
If Local Directory is disabled for the directory, tap  -> **All Contacts** or tap  -> **Directory** -> **All Contacts** to enter the local directory.
- Tap  after the desired contact.
- Tap **Blacklist**.

The touch screen prompts the following warning:

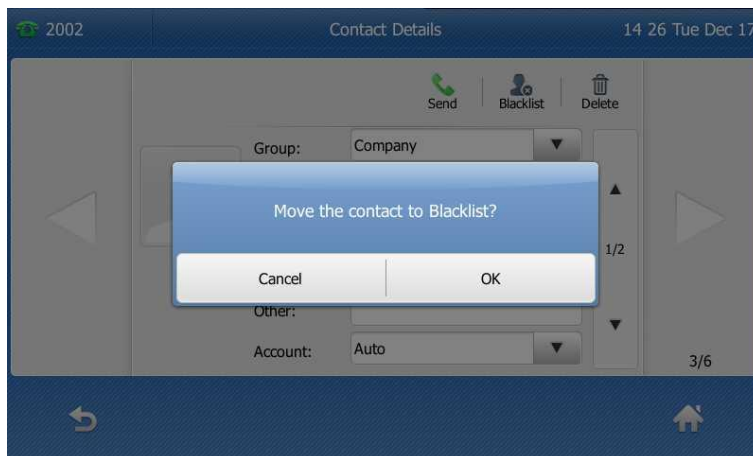

- Tap the **OK** soft key to confirm the setting.

For operating instructions on editing, deleting, placing calls to and searching for contacts in the blacklist directory, refer to the operating instructions of [Local Directory](#) on

page 36.

## Remote Phone Book

You can add local contacts, search for a contact, or simply dial a contact number from the corporate directory.

You can configure your new phone to access up to 5 corporate directories. The phone supports up to 5000 corporate directory entries. For the access URL of the corporate directory, contact your system administrator.

**To configure an access URL for remote phone book via web user interface:**

1. Click on **Directory->Remote Phone Book**.
2. Enter the access URL in the **Remote URL** field.
3. Enter the name in the **Display Name** field.

Index	Remote URL	Display Name
1	http://10.3.6.222/directory.xml	Sales
2		
3		
4		
5		

Search Remote Phonebook Name: Disabled

Search Flash Time(Seconds): 21600

NOTE: Remote Phone Book. This feature allows you to download contact list from the server. Input the phonebook URL and rename the phone book.

4. Click **Confirm** to accept the change.

**Note** An access URL for remote phone book is configurable via web user interface only.

**To access your corporate directory via phone user interface:**

1. Tap  -> **Remote Phone Book**.
2. Tap the desired remote phone book.

The phone connects to load the corporate directory, and then displays corporate contacts on the touch screen.



You can tap  to back to the previous interface.

**To search for a contact in the corporate directory:**

1. Tap  -> **Remote Phone Book**.
2. Tap **Search**.
3. Enter a few continuous characters of the contact name or continuous numbers of the contact number using the keypad.

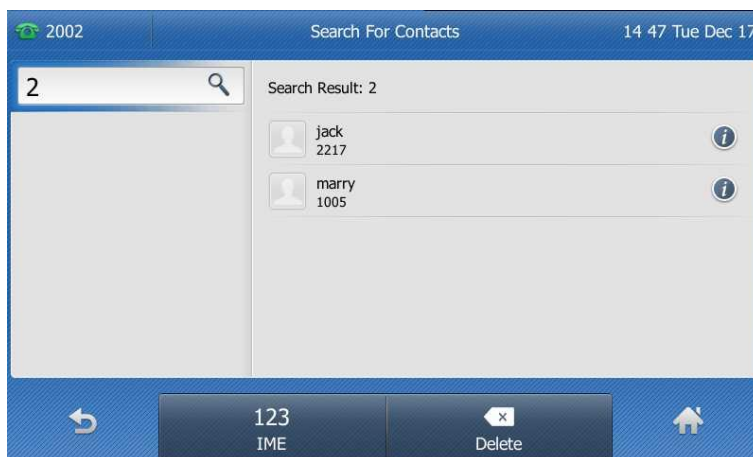

The contacts whose name or phone number matches the characters entered will appear on the touch screen. You can place a call from the result list.

**To place a call from the corporate directory:**

1. Tap  -> **Remote Phone Book**.
2. Tap the desired remote phone book to load the corporate directory.
3. Tap the desired contact in the corporate directory.

In addition, you can enable the phone to present the caller identity stored in the corporate directory when receiving a call.

To enable the presentation of caller identity stored in remote phone book via web user interface:

1. Click on **Directory->Remote Phone Book**.
2. Select **Enabled** from the pull-down list of **Search Remote Phonebook Name**.
3. Enter the refresh period in the **Search Flash Time (Seconds)** field.

The default value is 21600 seconds.

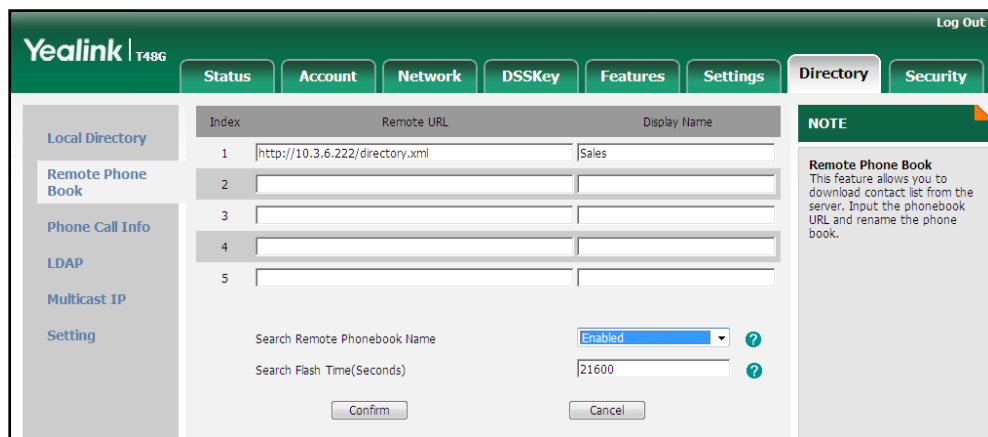

4. Click **Confirm** to accept the change.

## Call History Management

The SIP-T48G IP phone maintains call history lists of Missed calls, Placed calls, Received calls and Forwarded calls. Call history lists support 400 entries in all. You can view the call history, place a call, add a contact or delete an entry from the call history list. You should enable history record in advance.



To enable history record via phone user interface:

1. Tap  -> **Call Features->General**.
2. Tap the **On** radio box of the **History Record** field.



3. Tap the **Save** soft key to accept the change or  to cancel.

**To view the call history:**

1. Tap  .  
The touch screen displays all call records.
2. Tap ▲ or ▼ to turn pages.  
You can also press ▲ or ▼ to switch pages.  
You can tap **Missed**, **Placed**, **Received** or **Forwarded** to view entries in each call list directly.
3. Tap  after the desired entry.  
The detailed information of the entry appears on the touch screen.

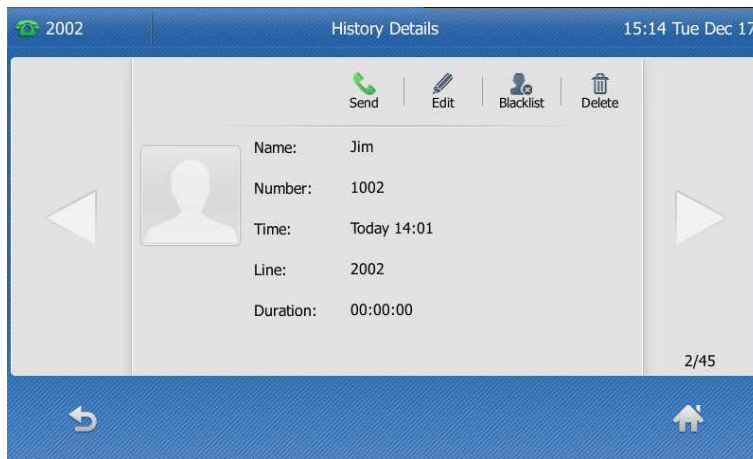



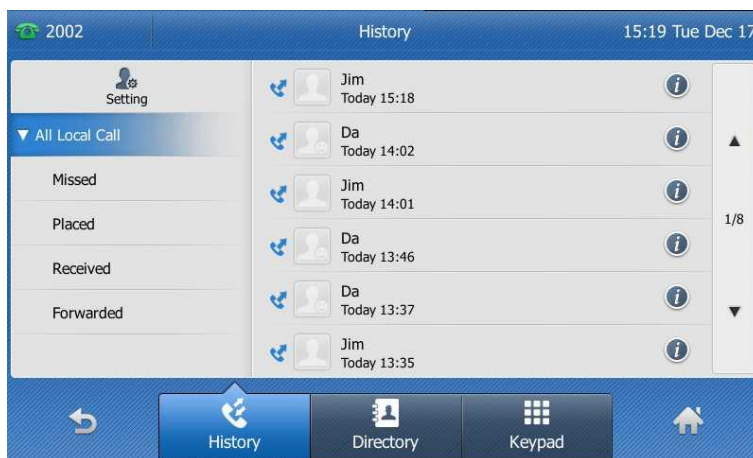

**To place a call from the call history list:**

1. Tap  .  
The touch screen displays all call records.
2. Tap ▲ or ▼ to turn pages.  
You can also press ▲ or ▼ to switch pages.  
You can tap **Missed**, **Placed**, **Received** or **Forwarded** to view entries in each call list directly.



3. Tap the desired entry.

**To add a contact to the blacklist directory from the call history list:**



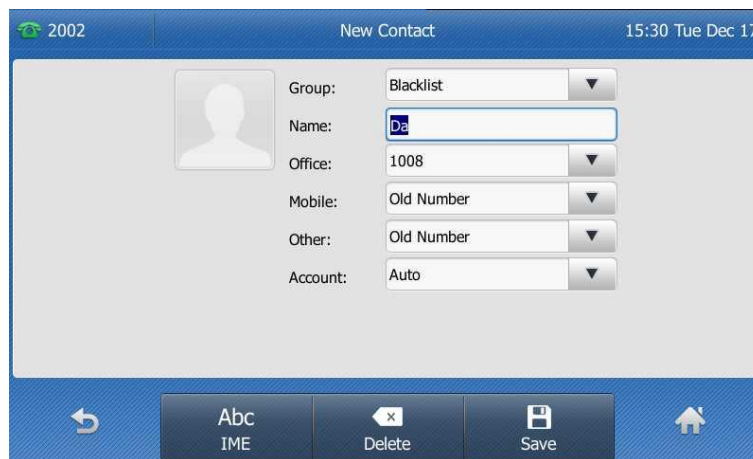

1. Tap  .  
The touch screen displays all call records.
2. Tap ▲ or ▼ to turn pages.  
You can also press  or  to switch pages.  
You can tap **Missed**, **Placed**, **Received** or **Forwarded** to view entries in each call list directly.
3. Tap  after the desired entry.
4. Tap **Blacklist**.



5. Enter the desired values in the corresponding fields.
6. Tap the **Save** soft key.

For more information, refer to [Contact Management](#) on page 34.

**To delete an entry from the call history list:**

1. Tap  .  
The touch screen displays all call records.
2. Tap ▲ or ▼ to turn pages.  
You can also press  or  to switch pages.  
You can tap **Missed**, **Placed**, **Received** or **Forwarded** to view entries in each call list directly.
3. Tap  after the desired entry.
4. Tap **Delete**.



The touch screen prompts the following warning:

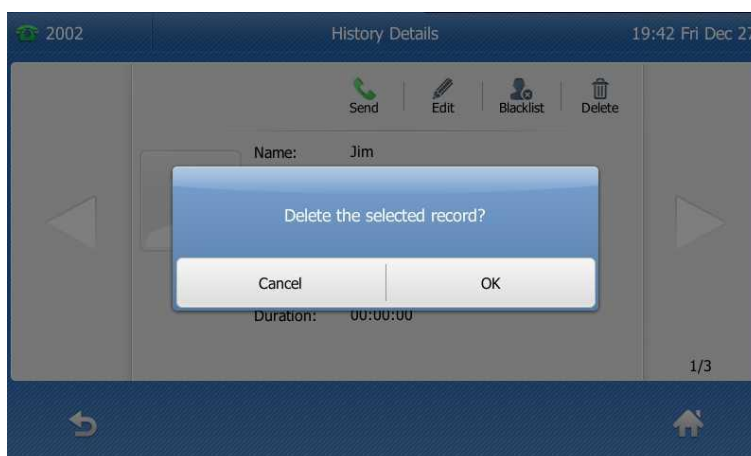

5. Tap the **OK** soft key to confirm the deletion or the **Cancel** soft key to cancel.

**To delete all entries from the call history list:**

1. Tap  .  
The touch screen displays all call records.
2. Tap ▲ or ▼ to turn pages.  
You can also press (▲) or (▼) to switch pages.  
You can tap **Missed**, **Placed**, **Received** or **Forwarded** to view entries in each call list directly.
3. Tap **Setting**.
4. Tap the checkbox of **Select All**.

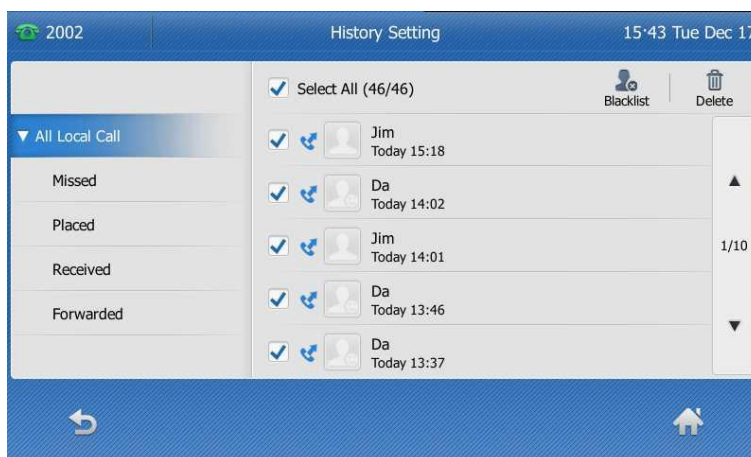

5. Tap **Delete**.



The touch screen prompts the following warning:

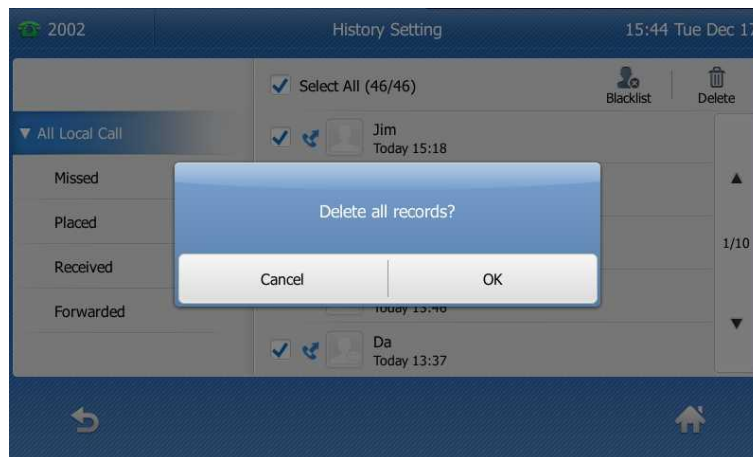

6. Tap the **OK** soft key to confirm the deletion or the **Cancel** soft key to cancel.

## System Customizations

### Headset Use

If you want to use a wired headset, physically connect your headset and activate the headset mode for use. For more information on physically connecting a headset, refer to [Phone Installation](#) on page 11.

If you want to use a wireless headset, insert the Bluetooth USB dongle BT40 into the USB port on the back of the phone. For more information on using a Bluetooth headset, refer to [Bluetooth Headset](#) on page 61.

This section provides the introduction of the wired headset.

#### Note

If both a Bluetooth headset and a wired headset are connected, only the Bluetooth headset can be used.

### Headset Mode Activation/Deactivation

**To activate the headset mode:**



1. Press  on the phone.

The HEADSET key LED illuminates solid green, and the icon  appears on the status bar of the touch screen when the headset mode is activated. When you tap the line key or the **Answer** soft key to answer an incoming call, the call is connected to your headset automatically. For more information on using the headset to answer a call, refer to [Answering Calls](#) on page 90.

With the handset on-hook, enter the desired number and tap the **Send** soft key, then the phone will place a call using the headset automatically. For more information on

using the headset to place a call, refer to [Placing Calls](#) on page 88.

**To deactivate the headset mode:**

1. Press  again on the phone.  
The HEADSET key LED goes out, and the icon  disappears from the touch screen when the headset mode is deactivated.

## Headset Prior

You can use headset in priority when enabling headset prior. This feature is especially useful for permanent or full-time headset users.

**To enable headset prior via web user interface:**

1. Click on **Features->General Information**.
2. Select **Enabled** from the pull-down list of **Headset Prior**.

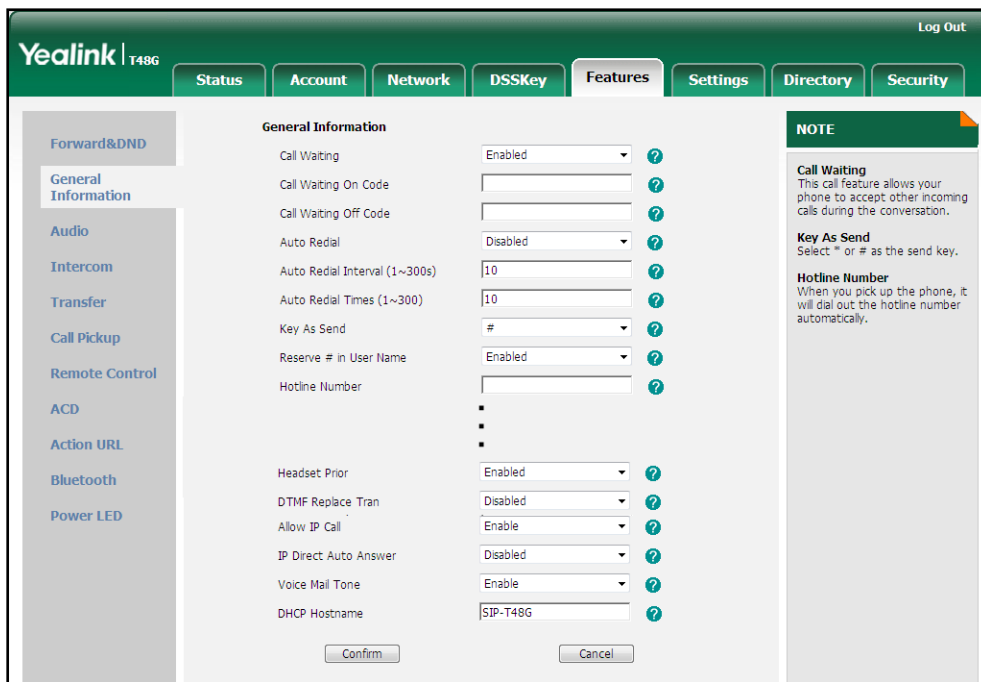

3. Click **Confirm** to accept the change.

**To use headset prior, you should activate the headset mode in advance:**

1. Physically connect the headset.
2. Press  to activate the headset mode.

**Note** If headset prior is enabled, the headset mode will not be deactivated until you press the HEADSET key again.  
Headset prior is configurable via web user interface only.

## Dual Headset

You can use two headsets when enabling dual headset. To use this feature, you must physically connect headsets to the headset jack and handset jack respectively. Once the phone connects to a call, the headset connected to the headset jack will have full-duplex capabilities, while the one connected to the handset jack will only be able to listen.

To enable dual headset via web user interface:

1. Click on **Features->General Information**.
2. Select **Enabled** from the pull-down list of **Dual-Headset**.

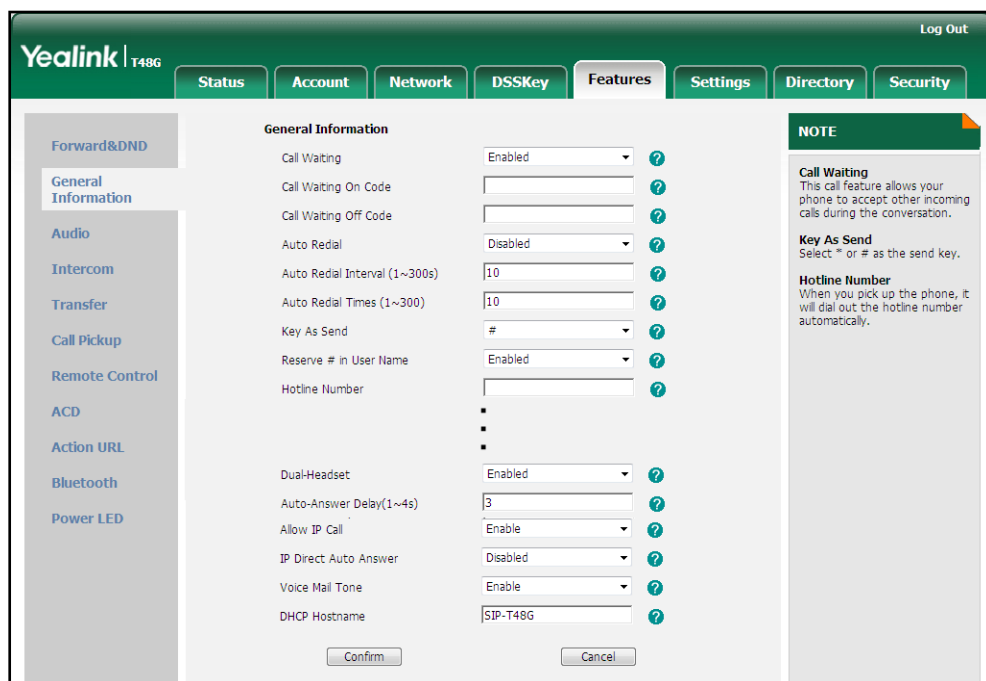

3. Click **Confirm** to accept the change.

**Note** Dual headset is configurable via web user interface only.

## Bluetooth Headset

The SIP-T48G IP phone supports Bluetooth. Bluetooth enables low-bandwidth wireless connections within a range of 10 meters (32 feet). The best performance is in the 1- to 2-meter (3- to 6-foot) range.

You can activate/deactivate the Bluetooth mode, and then pair and connect the Bluetooth headset with your phone. You can also disconnect and delete your Bluetooth headset from the phone.

**Note** Ensure that the Bluetooth USB dongle BT40 is properly connected into the USB port on the back of the phone. For more information, refer to [Phone Installation](#) on page 11.

**To activate the Bluetooth mode via phone user interface:**

1. Tap  -> **Basic**->**Bluetooth**.
2. Tap the **On** radio box of the **Bluetooth** field.

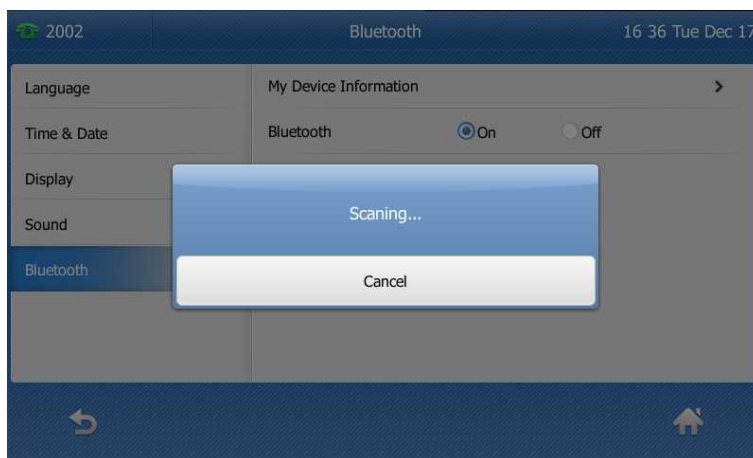

The IP phone scans the available Bluetooth headset automatically.

The touch screen displays the Bluetooth icon  and the Bluetooth device information (device name and MAC address).



Before you pair a Bluetooth headset, check the indicator on the Bluetooth headset to make sure the Bluetooth headset is discoverable. For more information, refer to the documentation from the Bluetooth headset manufacturer.

**To pair and connect your Bluetooth headset to your phone:**

1. Tap  -> **Basic**->**Bluetooth**.
2. Tap the found Bluetooth device to connect the Bluetooth headset to your phone.

When there is no found Bluetooth devices on the touch screen, tap the **Scan** soft key to search the Bluetooth device.



The phone prompts you to enter the password.

3. Enter the PIN in the **Password** field.

The default PIN is "0000".



4. Tap the **OK** soft key.

After a while, the Bluetooth headset is automatically connected to your phone. The touch screen displays as below:



The Bluetooth icon  appears on the touch screen.



With the Bluetooth headset paired and connected, you can use the Bluetooth headset to place and answer calls. For more information, refer to the documentation from the Bluetooth headset manufacturer.

Auto connection feature enables or disables the phone to connect with the Bluetooth headset automatically. This feature is enabled by default.

**To disable auto connection feature via phone user interface:**

1. Tap  -> **Basic**->**Bluetooth**.

The touch screen displays the paired and connected Bluetooth headset.



2. Tap  after the desired Bluetooth headset.

3. Tap the **Off** radio box of the **Auto Connect** field.

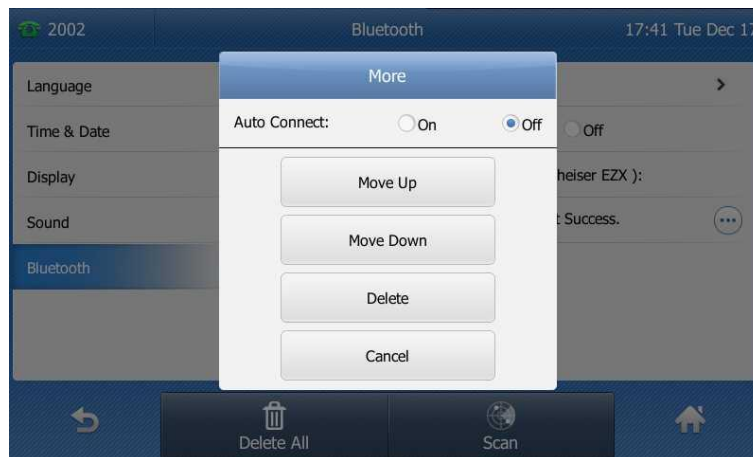

#### To change the priority of paired Bluetooth devices:

1. Tap  -> **Basic**->**Bluetooth**.
2. Tap  after the desired Bluetooth headset.
3. Tap **Move Up** or **Move Down** from the prompt list.

The top one has the highest priority. When there is no Bluetooth headset connected, the phone will automatically connect to a Bluetooth headset with the highest priority.

You can disconnect the Bluetooth headset from your phone. When you disconnect the Bluetooth headset, it still displays in the **Bluetooth Devices** list. You can easily connect it to your phone again.

#### To disconnect your Bluetooth headset from your phone:

1. Tap  -> **Basic**->**Bluetooth**.
2. Tap the connected Bluetooth headset.





The Bluetooth headset is disconnected. To connect it to your phone again, tap the Bluetooth headset again.

You can delete your Bluetooth headset from your phone. When you delete the Bluetooth headset, it disappears from the **Bluetooth Devices** list. To connect it to your phone again,



you need to scan and connect it again.

**To delete your Bluetooth headset from your phone:**

1. Tap  -> **Basic**->**Bluetooth**.
2. Tap  after the desired Bluetooth headset you want to delete.
3. Tap the **Delete** soft key from the prompt list.

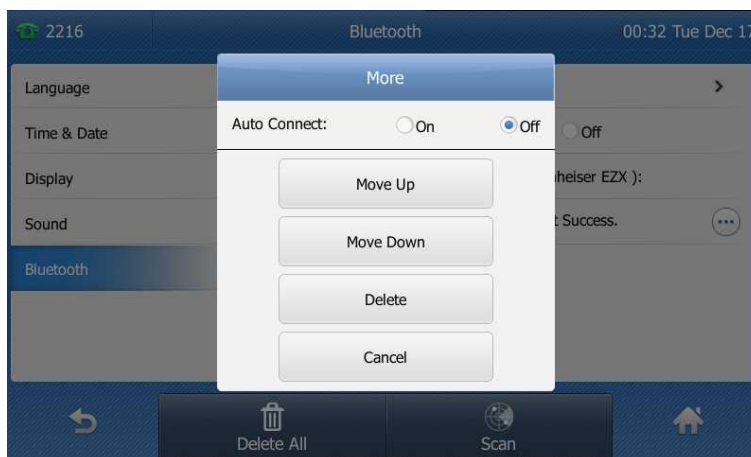

The touch screen prompts the following warning “Delete the selected item?”.

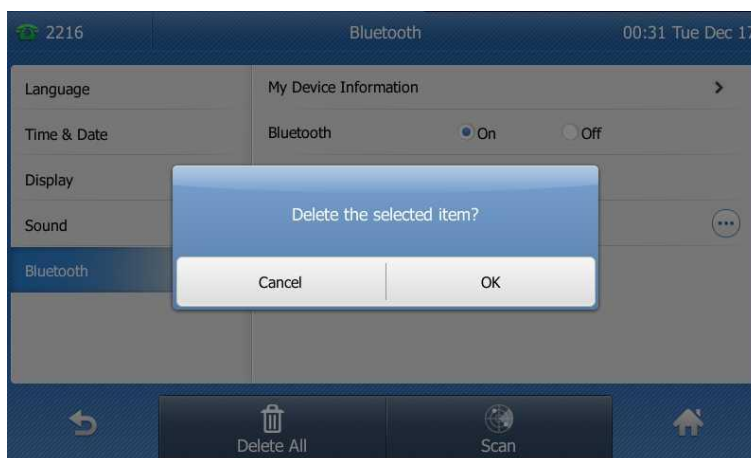

4. Tap the **OK** soft key to confirm the deletion or the **Cancel** soft key to cancel.

You can also delete all headsets by tapping the **Delete All** soft key.

**Note** If you cannot connect a Bluetooth headset to the phone successfully, we recommend you to delete the Bluetooth headset in the **Bluetooth Devices** list (if existed) before pairing it.

**To deactivate the Bluetooth mode via phone user interface:**

1. Tap  -> **Basic**->**Bluetooth**.



2. Tap the **Off** radio box of the **Bluetooth** field.



The Bluetooth icon  disappears from the touch screen.

Bluetooth mode is configurable via web user interface at the path **Features->Bluetooth**.

## DSS Keys

Two types of DSS keys: Line Keys and Programmable Keys. Details will be introduced in the following. The SIP-T48G IP phone supports 30 line keys.

## Line Keys

You can assign predefined functionalities to line keys. You can also define a label for line key feature which will appear on the touch screen. Line keys allow you to quickly access features such as call return and voice mail. The line key can indicate the monitored status when the line keys are assigned with particular features, such as BLF. The default key type of line key 1-6 is Line. The default key type of line key 30 is DSS Key, which provides a quick access to the line key configuration screen. You can also tap the line keys 1-11 on the idle screen to enter into the line key configuration screen directly.

**To assign functionality to the line key via phone user interface:**

1. Tap  -> **Call Features**-> **DSS Keys**.
2. Tap the desired line key.
3. Select the desired key type from the **Type** field.
4. (Optional.) Select the desired key event type from the **Key Event** field.
5. (Optional.) Select the desired line from the **Account ID** field.
6. (Optional.) Enter a label that will appear on the touch screen in the **Label** field.
7. (Optional.) Enter the corresponding value in the **Value** field.
8. (Optional.) Enter the corresponding value in the **Extension** field.

This option is only applicable to BLF feature. For more information, refer to [Busy Lamp Field \(BLF\)](#) on page 125.

9. Tap the **Save** soft key to accept the change or  to cancel.

You can also tap the line key 30 (DSS Key), and then tap the desired line key to assign functionality to it.

Line key features are explained in the following subchapters in detail:

- Line
- Speed Dial
- Voice Mail
- Directed Pickup
- Group Pickup
- DTMF
- Prefix
- Local Group
- XML Group
- XML Brower
- LDAP
- Conference
- Forward
- Transfer
- Hold
- DND
- Group Listening
- Zero Touch
- URL
- Directory

For more information, contact your system administrator.

### **Line**

You can use this key feature to accept the incoming calls, place active calls on hold or resume a held call. It performs the same as a hard line key.

**Dependencies:** *Type (Line)*

*Account ID (the account this feature will be applied to)*

**Usage:** When the phone receives an incoming call,

1. Tap the line key to accept the incoming call.
2. Tap the line key to place the active call on hold.
3. Tap the line key again to resume the held call.

## Speed Dial

You can use this key feature to speed up dialing the numbers often used or hard to remember.

**Dependencies:** *Type (Speed Dial)*

*Account ID (the account this feature will be applied to)*

*Label (key label displayed on the touch screen)*

*Value (the number you want to dial out)*

**Usage:** Tap the speed dial key to dial out the number specified in the **Value** field, using the account selected from the **Account ID** field.

## Voice Mail

You can use this key feature to connect voice mail quickly. For more information, refer to [Voice Mail](#) on page 140.

**Dependencies:** *Type (Key Event)*

*Key Event (Voice Mail)*

*Account ID (the account this feature will be applied to)*

*Label (key label displayed on the touch screen)*

*Value (the voice mail access code)*

**Usage:** Tap the voice mail key to dial out the voice mail access code, you can follow the voice prompt to listen to the voice mails.

## Directed Pickup

You can use this key feature to answer someone else's incoming call on the phone.

**Dependencies:** *Type (Key Event)*

*Key Event (Directed Pickup)*

*Account ID (the account this feature will be applied to)*

*Label (key label displayed on the touch screen)*

*Value (the directed pickup code followed by the specific phone number)*

**Usage:** Tap the directed pickup key on your phone when the specific phone number receives an incoming call. The call is answered on your phone.

## Group Pickup

You can use this key feature to answer incoming calls in a group that is associated with their own group.

**Dependencies:** *Type (Key Event)*

*Key Event (Group Pickup)*

*Account ID (the account this feature will be applied to)*

*Label (key label displayed on the touch screen)*

*Value (the group pickup code)*

**Usage:** Tap the group pickup key on your phone when a phone number in the group receives an incoming call. The call is answered on your phone.

#### **DTMF**

You can use this key feature to send the specification of arbitrary key sequences via DTMF.

**Dependencies:** *Type (Key Event)*

*Key Event (DTMF)*

*Label (key label displayed on the touch screen)*

*Value (DTMF sequence)*

#### **Note**

DTMF sequence can only contain "0-9", "\*", "#", and "A-D".

**Usage:** Tap the DTMF key during an active call to send the key sequence specified in the **Value** field.

#### **Prefix**

You can use this key feature to add a specified prefix number before the dialing number.

**Dependencies:** *Type (Key Event)*

*Key Event (Prefix)*

*Label (key label displayed on the touch screen)*

*Value (the prefix number)*

**Usage:** Tap the prefix key when the phone is idle, then the phone will enter into the pre-dialing screen and display the prefix number which you specified in the **Value** field. You can enter other digits and then dial out.

#### **Local Group**

You can use this key feature to access the contact group in the local directory quickly. For more information, refer to [Local Directory](#) on page 36.

**Dependencies:** *Type (Key Event)*

*Key Event (Local Group)*

*Local Group (the contact group name you want to access)*

*Label (key label displayed on the touch screen)*

**Usage:** Tap the local group key to access the contact group specified in the **Local Group** field.

#### **XML Group**

You can use this key feature to access remote group in your corporate directory quickly. You should configure remote phone book in advance. For more information, refer to [Remote Phone Book](#) on page 53.

**Dependencies:** *Type (Key Event)*

*Key Event (XML Group)*

*XML Group (the remote group name you want to access if remote phone book is configured)*

*Label (key label displayed on the touch screen)*

**Usage:** Tap the XML group key to access the remote group specified in the **XML Group** field.

### XML Browser

You can use this key feature to access the XML browser quickly. The XML browser allows you to create custom services which meet your functional requirements on the server. You can customize practical applications, such as weather report, stock information, Google search, etc.

**Dependencies:** *Type (Key Event)*

*Key Event (XML Browser)*

*Label (key label displayed on the touch screen)*

*Value (the access URL for XML browser)*

**Usage:** Tap the XML browser key to access the XML browser specified in the **Value** field.

### LDAP

You can use this key feature to access the LDAP search interface quickly.

**Dependencies:** *Type (Key Event)*

*Key Event (LDAP)*

*Label (key label displayed on the touch screen)*

**Usage:**

1. Tap the LDAP key to access the LDAP search interface.
2. Enter a few continuous characters of the contact name or continuous numbers of the contact number using the keypad.

The contacts whose name or phone number matches the characters entered will appear on the touch screen.

### Conference

You can use this key feature to set up a conference call. For more information, refer to [Conference](#) on page 113.

**Dependencies:** *Type (Key Event)*

*Key Event (Conference)*

*Label (key label displayed on the touch screen)*

*Value (the number you want to add to the conference)*

**Usage:** Tap the conference key during an active call to set up a conference with the number specified in the **Value** field.

**Note**

When leaving the **Value** field blank, the conference key performs the same as the **Conference** soft key during a call.

### Forward

You can use this key feature to forward an incoming call to someone else. For more information, refer to [Call Forward](#) on page 104.

**Dependencies:** *Type (Key Event)*

*Key Event (Forward)*

*Label (key label displayed on the touch screen)*

*Value (the number you want to forward to)*

**Usage:**

1. Tap the forward key to forward an incoming call to the number specified in the **Value** field.
2. When call forward is in phone mode, tap the forward key to activate call forward for the phone.
3. When call forward is in custom mode, tap the forward key to access the custom call forward interface. You can activate or deactivate call forward for one or all accounts.

**Note**

If the **Value** field is left blank, the forward key performs the same as the **Forward** soft key when receiving an incoming call.

### Transfer

You can use this key feature to handle the call differently depending on the transfer mode on DSS key when there is an active call on the phone.

**Dependencies:** *Type (Key Event)*

*Key Event (Transfer)*

*Label (key label displayed on the touch screen)*

*Value (the number you want to transfer to)*

**Usage:**

- When the transfer mode on DSS key is **Blind Transfer**, tap the transfer key to complete the blind transfer to the number specified in the **Value** field.
- When the transfer mode on DSS key is **Attended Transfer**, tap the transfer key to dial out the number specified in the **Value** field, and then perform the attended or semi-attended transfer.
- When the transfer mode on DSS key is **New Call**, tap the transfer key to place a

new call to the number specified in the **Value** field.

#### Note

Transfer mode via DSS key is configurable via web user interface at the path **Features->Transfer**. For more information on how to configure the transfer mode via DSS key, refer to [Busy Lamp Field \(BLF\)](#) on page 125.

When leaving the **Value** field blank, the transfer key performs the same as the **TRANSFER** key or the **Transfer** soft key during a call. For more information, refer to [Call Transfer](#) on page 111.

#### Hold

You can use this key feature to place an active call on hold or retrieve a held call.

**Dependencies:** *Type (Key Event)*

*Key Event (Hold)*

*Label (key label displayed on the touch screen)*

**Usage:**

1. Tap the hold key during an active call to place the call on hold.
2. Tap the hold key again to retrieve the held call.

#### DND

You can use this key feature to activate or deactivate DND. You can also use this key feature to access the custom DND screen. For more information, refer to [Do Not Disturb \(DND\)](#) on page 99.

**Dependencies:** *Type (Key Event)*

*Key Event (DND)*

*Label (key label displayed on the touch screen)*

**Usage:**

When DND is in phone mode:

1. Tap the DND key to activate DND.
2. Tap the DND key again to deactivate DND.

When DND is in custom mode:

1. Tap the DND key to access the custom DND screen. You can activate or deactivate DND for one or all accounts.

#### Group Listening

You can use this key feature to activate the Speakerphone and Handset/Headset mode at the same time. It is suitable for the group conversation which has more than one person at one side. You are able to speak and listen through the handset/headset, meanwhile the others nearby can only listen through the speaker.

**Dependencies:** *Type (Key Event)*

*Key Event (Group Listening)*

*Label (key label displayed on the touch screen)*

**Usage:**

1. During a call, tap the group listening key to activate the group listening mode.  
You can then speak and listen through the handset/headset, other people at your side can listen through speaker at the same time.
2. Tap the group listening key again to deactivate the group listening mode.

**Zero Touch**

You can use this key feature to configure auto provision and network parameters quickly.

**Dependencies:** *Type (Key Event)*

*Key Event (Zero Touch)*

*Label (key label displayed on the touch screen)*

**Usage:**

1. Tap the zero touch key to access the zero touch screen.
2. Tap the **OK** soft key within a few seconds.
3. Configure the network parameters in the corresponding fields.
4. Tap the **Next** soft key.
5. Configure the auto provision parameters in the corresponding fields.
6. Tap the **Next** soft key.  
The phone will reboot to update configurations.

**URL**

You can use this key feature to trigger the phone to send an HTTP GET request containing a specific URL.

**Dependencies:** *Type (URL)*

*Label (key label displayed on the touch screen)*

*URL (the URL contained in the HTTP GET request)*

**Usage:** Tap the URL key to trigger the phone to send an HTTP GET request containing the URL specified in the **URL** field.

**Directory**

You can use this key feature to easily access frequently used lists. For more information, refer to [Directory](#) on page 34.

**Dependencies:** *Type (Key Event)*

*Key Event (Directory)*

*Label (key label displayed on the touch screen)*

**Usage:** Tap the directory key to immediately access to frequently used lists.

**Note**

The directory key performs the same function as the **Directory** soft key when the phone is idle.



## Programmable Keys

You can customize the soft keys, navigation keys and function keys.

To customize the programmable keys via web user interface:

1. Click on **DSSKey->Programmable Key**.
2. Customize specific features for these keys.

Key	Type	Line	Value	Label	Extension
SoftKey 1	History	Local History			
SoftKey 2	Directory	N/A			
SoftKey 3	DND	N/A			
SoftKey 4	Menu	N/A			
Up	History	Local History			
Down	N/A	N/A			
Left	Switch Account	N/A			
Right	Switch Account	N/A			
OK	Status	N/A			
Cancel	N/A	N/A			
HOLD	N/A	N/A			
MUTE	N/A	N/A			
TRAN	Forward	N/A			

3. Click **Confirm** to accept the change.

You can click **Reset to default** to reset custom settings to defaults.

**Note** Programmable keys are configurable via web user interface only.

## Account Management

You can register one or multiple accounts on the SIP-T48G IP phone. You can also configure each line key to associate with an account or configure multiple line keys to associate with an account.

### Account Registration

To register an account via phone user interface:

1. Tap  -> **Advanced** (password: admin) -> **Account**.
2. Tap the desired account.
3. Tap the gray box of the **Account Status** field.
4. Tap **Enabled** from the pull-down list.
5. Enter the desired values in the **Label**, **Display Name**, **Register Name**, **User Name**, **Password** and **SIP Server1/2** fields respectively. Contact your system administrator

for more information.

6. Tap the **Save** soft key to accept the change or ↶ to cancel.

You can repeat steps 2 to 5 to register more accounts.

The following figures show single or multiple accounts registered on the phone:

**Single account:**



**Multiple accounts:**



**To disable an account via phone user interface:**

1. Tap  -> **Advanced** (password: admin) -> **Account**.
2. Tap the desired account.
3. Tap the gray box of the **Account Status** field.
4. Tap **Disabled** from the pull-down list.
5. Tap the **Save** soft key to accept the change or ↶ to cancel.

Account registration is configurable via web user interface at the path **Account->Register**.

To configure the default account via phone user interface:

1. Tap  -> **Call Features**->**Default Account**.
2. Tap the gray box of the **Default Account** field.
3. Tap the desired account from the pull-down list.



4. Tap the **Save** soft key to accept the change or  to cancel.

The label of the default account is displayed on the left of the status bar. The IP phone will use this account by default when dialing out.

## Multiple Line Keys per Account

You can configure multiple line keys to associate with an account. This enhances call visualization and simplifies call handling.

If this is the case, the touch screen resembles the following figure:



Incoming calls to this account will be distributed evenly among the available line keys. Outgoing calls will be distributed similarly.

Your phone can be configured to have a combination of accounts with a single line key and accounts with multiple line keys.

## Dial Plan

Dial plan is a string of characters that governs the way your SIP-T48G IP phone processes the inputs received from your phone keypad. The SIP-T48G IP phone supports the following dial plan features:

- [Replace Rule](#)
- [Dial-now](#)
- [Area Code](#)
- [Block Out](#)

Basic expression syntaxes you need to know:

Syntax	Description
.	The dot "." can be used as a placeholder or multiple placeholders for any character. Example: "12." would match "123", "1234", "12345", "12abc", etc.
x	An "x" can be used as a placeholder for any character. Example: "12x" would match "121", "122", "123", "12a", etc.
[]	The square brackets "[]" can be used as a placeholder for a single character which matches any of a set of characters. Example: "91[5-7]1234" would match "9151234", "9161234", "9171234", etc.
()	The parentheses "(" )" can be used to group together patterns, for instance, to logically combine two or more patterns. Example: "([1-9])([2-7])3" would match "923", "153", "773", etc.
\$	The "\$" should be followed by the sequence number of a parenthesis. The "\$" plus the sequence number means the whole character or characters placed in the parenthesis. The number directs to the right parenthesis when there are more than one. Example: A replace rule configuration: Prefix: "9([5-7])(.)", Replace: "5\$2". When you enter "96123" to dial out on your phone, the number will be replaced as "5123" and then dialed out. "\$2" means the characters in the second parenthesis, that is, "123".

## Replace Rule

You can configure one or more replace rules (up to 100) to remove the specified string and replace it with another string. You can configure a pattern with wildcards (refer to the expression syntax in the table above), so that any string that matches the pattern will be replaced. This feature is convenient for you to dial out a long number. For example, a replace rule is configured as "Prefix: 1" and "Replace: 1234567", when you try to dial out the number "1234567", you just need to enter "1" on the phone and then tap the Send soft key.

**To add a replace rule via web user interface:**

1. Click on **Settings->Dial Plan->Replace Rule**.
2. Enter the string (e.g., 2xx) in the **Prefix** field.
3. Enter the string (e.g., 12345) in the **Replace** field.
4. Enter the desired line ID in the **Account** field or leave it blank.

Index	Prefix	Area Code	Block Out	Account	
1					<input type="checkbox"/>
2					<input type="checkbox"/>
3					<input type="checkbox"/>
4					<input type="checkbox"/>
5					<input type="checkbox"/>
6					<input type="checkbox"/>
7					<input type="checkbox"/>
8					<input type="checkbox"/>
9					<input type="checkbox"/>
10					<input type="checkbox"/>

Prefix: 2xx      Replace: 12345      Account:

**NOTE**

**Digit 0-9 \***  
Identifies a specific digit (do not use # if it is defined as send key).

**[digit-digit]**  
Identifies any digit dialed that is included in the range.

**[digit-digit,digit]**  
Specifies a range as a comma separated list.

**x**  
Matches any single digit/character which is dialed.

**\***  
Matches an arbitrary number of digits.

5. Click **Add** to add the replace rule.

When you enter the number “234” using the keypad and then tap the **Send** soft key, the phone will dial out “12345” instead.

**Note**

Valid values of **Account** field can be one or more digits among 1, 2, 3, 4, 5 and 6. Every two digits must be separated by a comma. For example, when you enter the value “1, 2” in the **Account** field, this replace rule will apply to account1 and account2.

If you leave the **Account** field blank or enter 0, then the replace rule will apply to all accounts.

**To edit a replace rule via web user interface:**

1. Click on **Settings->Dial Plan->Replace Rule**.
2. Select the desired replace rule by checking the checkbox.
3. Edit the values in the **Prefix** and **Replace** fields.
4. Enter the desired line ID in the **Account** field or leave it blank.
5. Click **Edit** to accept the change.

**To delete one or more replace rules via web user interface:**

1. Click on **Settings->Dial Plan->Replace Rule**.
2. Select one or more replace rules by checking the checkbox(es).

3. Click **Del** to delete the replace rule(s).

**Note** Replace rule is configurable via web user interface only.

## Dial-now

You can configure one or more dial-now rules (up to 100) on your phone. When the dialed number matches the dial-now string, the number will be dialed out automatically. For example, a dial-now rule is configured as "2xx", then any entered three-digit string beginning with 2 will be dialed out automatically on the phone.

**To add a dial-now rule via web user interface:**

1. Click on **Settings->Dial Plan->Dial-now**.
2. Enter the desired value (e.g., 1234) in the **Rule** field.
3. Enter the desired line ID in the **Account** field or leave it blank.

For more information on the valid value of the **Account** field, refer to [Replace Rule](#) on page 78.

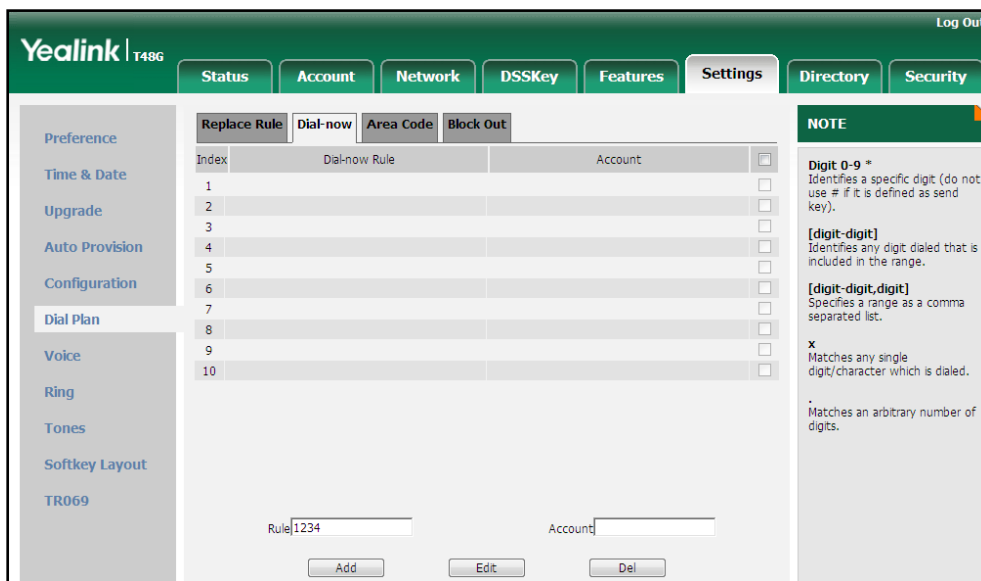

4. Click **Add** to add the dial-now rule.

When you enter the number "1234" using the keypad, the phone will dial out "1234" automatically without pressing any key.

**Note** You can also edit or delete the dial-now rule, refer to [Replace Rule](#) on page 78 for more information.

Dial-now rule is configurable via web user interface only.

### Delay Time for Dial-Now Rule

You can configure the delay time for dial-now rules. That is, you can configure your

phone to dial out the phone number automatically, which matches a dial-now rule, after the specified delay time.

To configure the delay time for dial-now rule via web user interface:

1. Click on **Features->General Information**.
2. Enter the time within 1-14 (in seconds) in the **Time-Out for Dial-Now Rule** field.

The default value is 1.

Setting	Value
Call Waiting	Enabled
Call Waiting On Code	
Call Waiting Off Code	
Auto Redial	Disabled
Auto Redial Interval (1~300s)	10
Auto Redial Times (1~300)	10
Key As Send	#
Reserve # in User Name	Enabled
Hotline Number	
Hotline Delay(0~10s)	4
Busy Tone Delay (Seconds)	0
Return Code When Refuse	486 (Busy Here)
Return Code When DND	480 (Temporarily Not A
Call Completion	Disabled
Time-Out for Dial-Now Rule	1
RFC 2543 Hold	Disabled

3. Click **Confirm** to accept the change.

### Note

Delay time for dial-now rule is configurable via web user interface only.

## Area Code

Area codes are also known as Numbering Plan Areas (NPAs). They usually indicate geographical areas in a country. This feature is necessary only when dialing the number outside the code area. For example, area code is configured as "Code: 011, Min Length: 4, Max Length: 11". When you dial out the number "56789" (the length of the number is between 4 and 11), the phone will add the area code and dial out the number "01156789".

To configure the area code and lengths via web user interface:

1. Click on **Settings->Dial Plan->Area Code**.
2. Enter the desired values in the **Code**, **Min Length (1-15)** and **Max Length (1-15)** fields.
3. Enter the desired line ID in the **Account** field or leave it blank.

For more information on the valid value of the **Account** field, refer to [Replace Rule](#) on page 78.

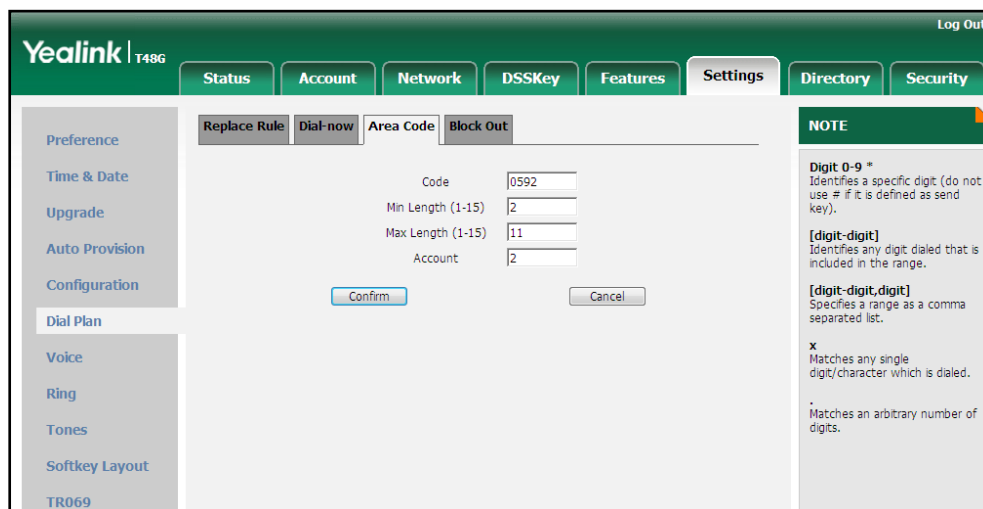

4. Click **Confirm** to accept the change.

**Note** The default values of minimum and maximum length are 1 and 15 respectively.  
Area code is configurable via web user interface only.

## Block Out

You can block some specific numbers (up to 10) from being dialed on your phone. When you dial a block out number on your phone, the dialing will fail and the touch screen will prompt "Forbidden Number".

**To add a block out number via web user interface:**

1. Click on **Settings->Dial Plan->Block Out**.
2. Enter the desired value in the **BlockOut Number** field.
3. Enter the desired line ID in the **Account** field or leave it blank.



For more information on the valid value of the **Account** field, refer to [Replace Rule](#) on page 78.

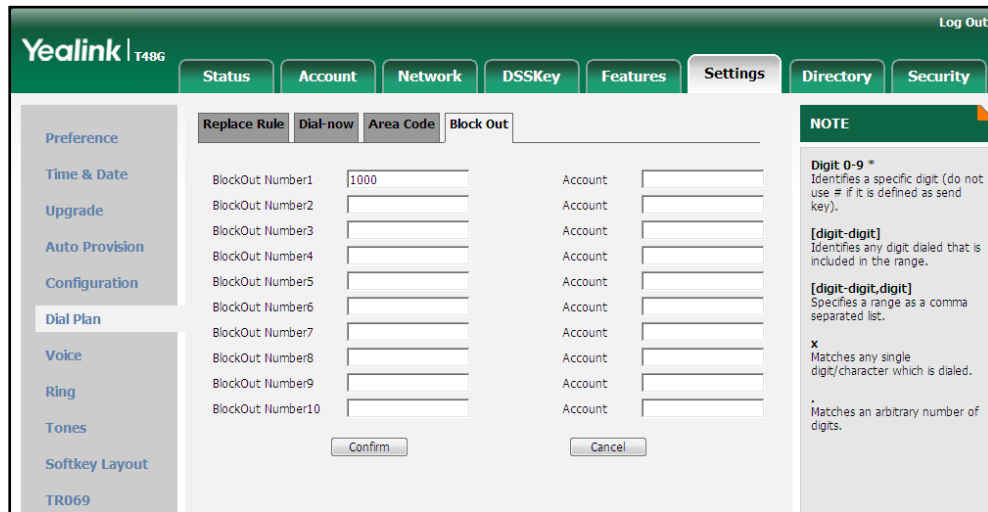

4. Click **Confirm** to add the block out number.

**Note** Block out number is configurable via web user interface only.

## Live Dialpad

You can enable live dialpad on the SIP-T48G IP phone, which enables the IP phone to automatically dial out the phone number without pressing any other key. You can also configure a delay, where the phone will dial out the phone number automatically after the specified period of time.

**To enable the live dialpad via web user interface:**

1. Click on **Settings->Preference**.
2. Select **Enabled** from the pull-down list of **Live Dialpad**.

3. Enter the desired delay time in the **Inter Digit Time (1~14s)** field.

The default delay time is 4s.

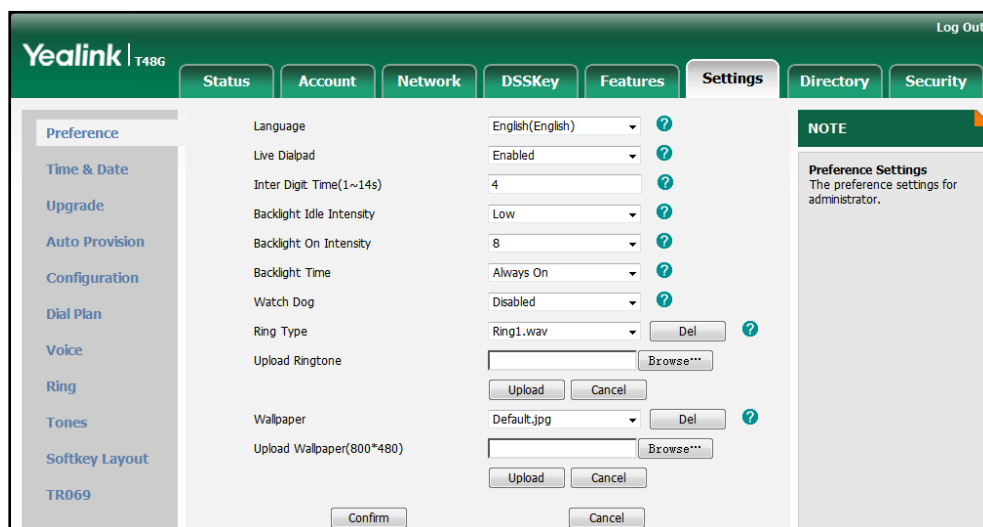

4. Click **Confirm** to accept the change.

**Note** Live dialpad is configurable via web user interface only.

## Hotline

You can dial a hotline number immediately upon lifting the handset, pressing the speakerphone key or tapping the line key. You can also configure a delay, where the phone will dial out the hotline number automatically after the specified period of time.

**To configure the hotline number via phone user interface:**

1. Tap  -> **Call Features**-> **Hotline**.
2. Enter the desired number in the **Number** field.
3. Enter the desired delay time in the **Hotline Delay 0-10(s)** field.

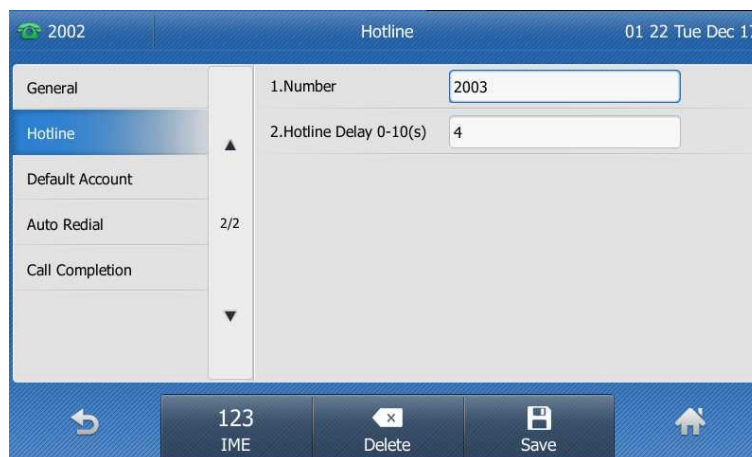

4. Tap the **Save** soft key to accept the change or  to cancel.

Hotline is configurable via web user interface at the path **Features->General Information**.



## Basic Call Features

---

The SIP-T48G IP phone is designed to be easily used like a regular phone on a public switched telephone network (PSTN). You can place calls, answer calls, transfer a call to someone else, or conduct a conference call.

This chapter provides basic operating instructions for the SIP-T48G IP phone. Topics include:

- [Placing Calls](#)
- [Answering Calls](#)
- [Ending Calls](#)
- [Redialing Numbers](#)
- [Recent Call In Dialing](#)
- [Auto Answer](#)
- [Auto Redial](#)
- [Call Completion](#)
- [Call Return](#)
- [Call Mute](#)
- [Call Hold/Resume](#)
- [Do Not Disturb \(DND\)](#)
- [Call Forward](#)
- [Call Transfer](#)
- [Call Waiting](#)
- [Conference](#)
- [Call Park](#)
- [Call Pickup](#)
- [Anonymous Call](#)
- [Anonymous Call Rejection](#)

If you require additional information or assistance with your new phone, contact your system administrator.

## Placing Calls

You can place a call in three ways using your SIP-T48G IP phone:

- Using the handset
- Using the speakerphone
- Using the headset

You can also dial the number first, and then choose the way you want to speak to the other party.

You can also search and dial a contact from the call history, local directory or remote phone book. For more information, refer to [Contact Management](#) on page 34 and [Call History Management](#) on page 55.

During a call, you can alternate between Speakerphone, Headset, and Handset modes by pressing the Speakerphone key, the HEADSET key, or picking up the handset.

The call duration of call is visible on the touch screen. In the figure below, the call to "Lin" has lasted 37 seconds.





### To place a call using the handset:

1. Pick up the handset.
2. Enter the desired number using the keypad.

You can enter the number using the keypad displayed on the touch screen. You can also tap the **History** soft key or the **Directory** soft key to search for an entry, and then place a call.



3. Press  ,  , or tap the **Send** soft key.

The # key is configured as a send key by default. You can also set the \* key as the send key, or set neither. For more information, refer to the [Key as Send](#) on page 31.







#### Note

You can also dial using the SIP URI or IP address. To obtain the IP address of a phone, press the **OK** key. The maximum SIP URI or IP address length is 32 characters. For example, SIP URI: 3606@sip.com, IP: 192.168.1.15.

Your phone may not support direct IP dialing. Contact your system administrator for more information.



#### To place a call using the hands-free speakerphone mode:



Do one of the following:

- With the handset on-hook, press  or tap the line key to obtain a dial tone.  
Enter the desired number using the keypad or the on-screen keypad.  
Press  ,  or tap the **Send** soft key.
- With the handset on-hook, enter the desired number using the keypad or the on-screen keypad.  
Press  ,  ,  or tap the **Send** soft key.

#### To place a call using the headset:

Do one of the following:





- With the optional headset connected, press  to activate the headset mode.  
Tap the line key to obtain a dial tone.  
Enter the desired number using the keypad or the on-screen keypad.  
Press  ,  , or tap the **Send** soft key.

- With the optional headset connected, press  to activate the headset mode. Enter the desired number using the keypad or the on-screen keypad. Press , , or tap the **Send** soft key.

**Note** To permanently use the headset mode, refer to [Headset Prior](#) on page 60.

### To place multiple calls:

You can have more than one call on your SIP-T48G IP phone. To place a new call during an active call, do one of the following:

- Tap the line key. The active call is placed on hold. Enter the desired number using the keypad or the on-screen keypad. Press , , or tap the **Send** soft key.
- Press  or tap the **Hold** soft key to place the original call on hold. Tap the **New Call** soft key. Enter the desired number using the keypad or the on-screen keypad. Press , , or tap the **Send** soft key.

You can tap the desired call, and then tap the **Resume** soft key to retrieve it.

## Answering Calls

When you are not in another call, you can answer a call in three ways:

- Using the handset
- Using the speakerphone
- Using the headset

**Note** You can ignore incoming calls by pressing the **X** key or tapping the **Reject** soft key or the **Silence** soft key. You can also activate Do Not Disturb mode to ignore the incoming calls without ring on your phone. For more information, refer to [Do Not Disturb \(DND\)](#) on page 99.

You can forward incoming calls to someone else by tapping the **Forward** soft key. For more information, refer to [Call Forward](#) on page 104.

### Answering When Not in Another Call

Call duration and destination will always appear on the touch screen for the active call.

#### To answer a call using the handset:

1. Pick up the handset.



**To answer a call using the hands-free speakerphone mode:**

Do one of the following:

- Press  .
- With the handset on-hook and the headset mode deactivated, tap the **Answer** soft key.
- With the handset on-hook and the headset mode deactivated, tap the line key (the line key illuminates green).



**To answer a call using the headset:**

Do one of the following:

- Press  .
- With the headset mode activated, tap the **Answer** soft key.
- With the headset mode activated, tap the line key (the line key illuminates green).

**Answering When in Another Call**

If you have an active call, and an incoming call arrives on the phone, do one of the following:

- Tap the **Answer** soft key.  
The incoming call is answered and the original call is placed on hold.
- Press  to access the new call.  
Press  or tap the **Answer** soft key.  
The incoming call is answered and the original call is placed on hold.

## Ending Calls

**To end a call:**

Do one of the following:

- If you are using the handset, tap the **End Call** soft key or hang up the handset.
- If you are using the headset, tap the **End Call** soft key.
- If you are using the speakerphone, press  or tap the **End Call** soft key.

**Note**

To end a call placed on hold, you can tap the **End Call** soft key to end the call directly, or tap the **Resume** soft key to resume the call before ending it.

## Redialing Numbers

To redial the last dialed number from your phone:

1. Press  twice.  
A call to your last dialed number is attempted.

To redial a previously dialed number from your phone:

1. Press  when the phone is idle.
2. Tap the desired entry from the placed calls list.

## Recent Call In Dialing

To view the placed calls list when the phone is in the pre-dialing interface, you should enable recent call in dialing in advance.

To enable recent call in dialing via web user interface:

1. Click on **Directory->Setting**.
2. Select **Enabled** from the pull-down list of **Recent Call In Dialing**.

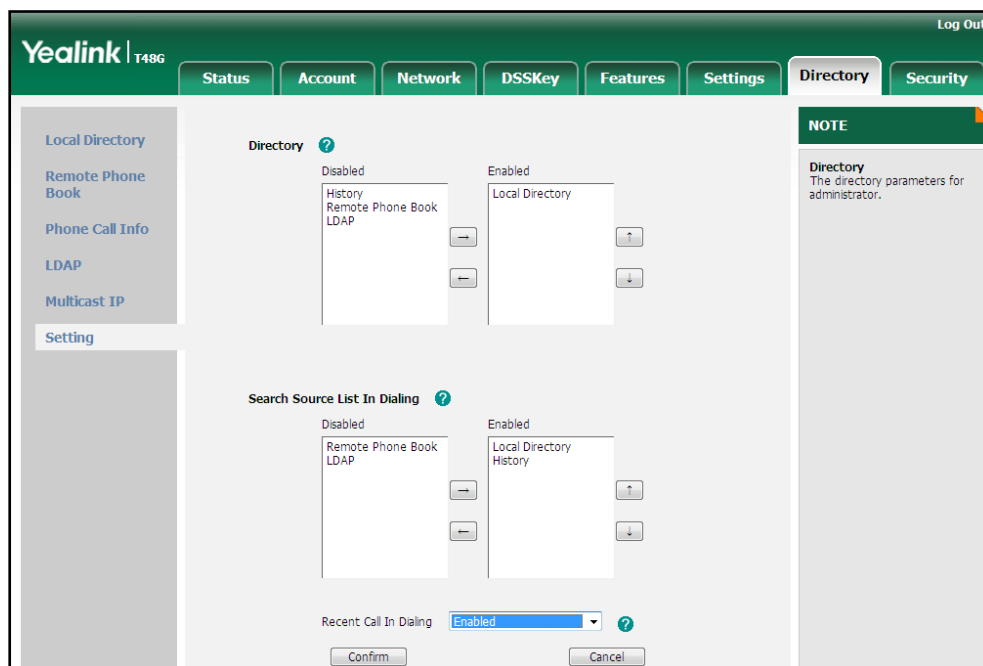

3. Click **Confirm** to accept the change.

### Note

Recent call in dialing is configurable via web user interface only.

To view placed calls list when the phone is in the pre-dialing interface:

1. Pick up the handset, press the speakerphone key or tap the line key.  
The touch screen displays the placed calls list.



You can tap ▲ or ▼ to scroll through placed calls page by page.

## Auto Answer

You can use auto answer to automatically answer an incoming call on a line. Auto answer is configurable on a per-line basis.

To configure auto answer via phone user interface:

1. Tap  -> **Call Features**->**Auto Answer**.
2. Tap the **On** radio box of the desired line.

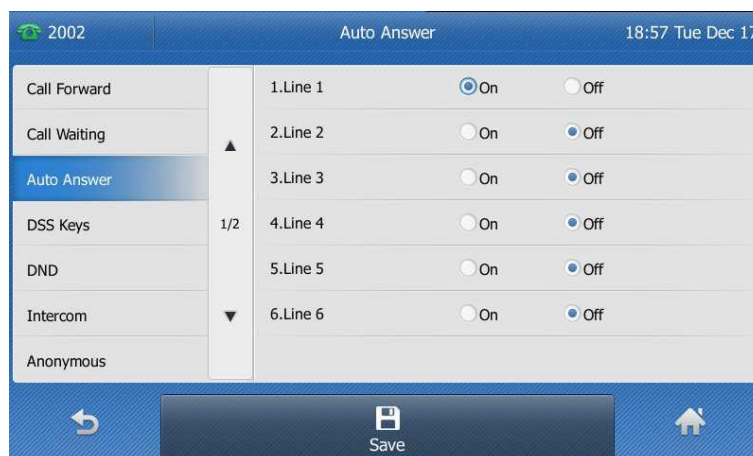

3. Tap the **Save** soft key to accept the change or  to cancel.

The **AA** icon appears on the touch screen.



Auto answer is configurable via web user interface at the path **Account->Basic**.

**Note** Auto answer is only applicable when there is no other call in progress on the phone.

## Auto Redial

You can enable auto redial to redial the phone number automatically when the called party is busy. You can also configure the times settings for auto redial and the time to wait between redial attempts.

**To configure auto redial via phone user interface:**

1. Tap  -> **Call Features**->**Auto Redial**.
2. Tap the **On** radio box of the **Auto Redial** field.
3. Enter the desired time (in seconds) in the **Redial Interval** field.  
The default time interval (in seconds) is 10.
4. Enter the desired times in the **Redial Times** field.  
The default value is 10.

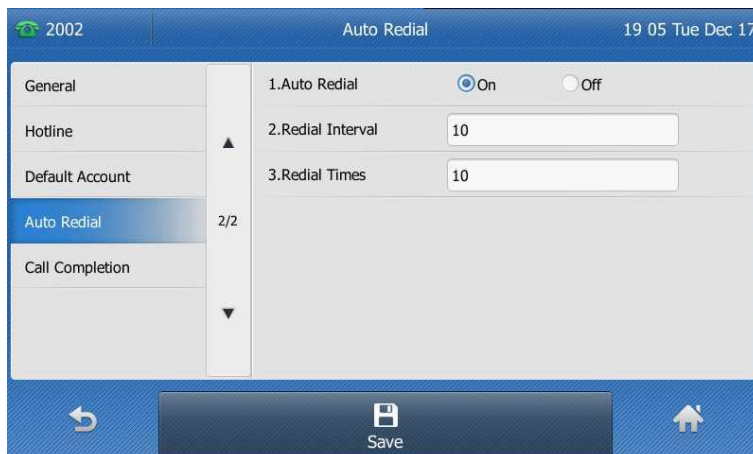

5. Tap the **Save** soft key to accept the change or  to cancel.

Auto redial is configurable via web user interface at the path **Features->General Information**.

**To use auto redial:**

When the called party is busy, the touch screen prompts the following:



1. Tap the **OK** soft key to activate auto redial.

The touch screen prompts the following:



2. Wait for a period of time or tap the **OK** soft key to redial the phone number.

The phone will retry as many times as configured until the called party is idle.

## Call Completion

You can use call completion to notify the caller who failed to reach a desired callee when the callee becomes available to receive a call.

**To enable call completion via phone user interface:**

1. Tap  -> **Call Features->Call Completion**.

2. Tap the **On** radio box of the **Call Completion** field.

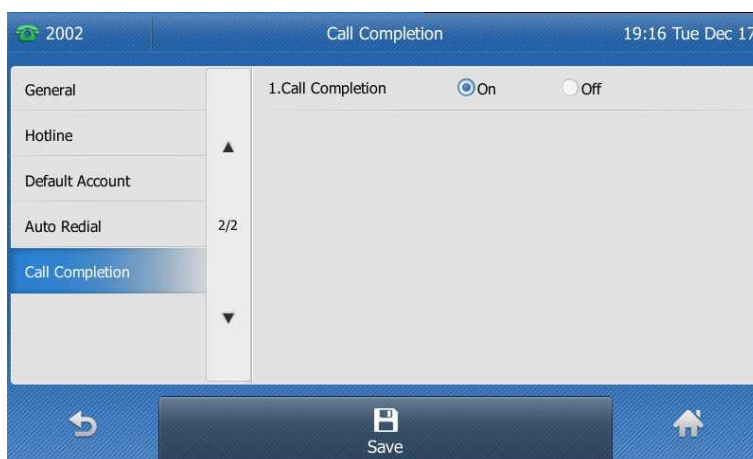

3. Tap the **Save** soft key to accept the change or  to cancel.

Call completion is configurable via web user interface at the path **Features->General Information**.

**To use call completion:**

When the called party is busy, the following prompt will appear on the touch screen of the phone:

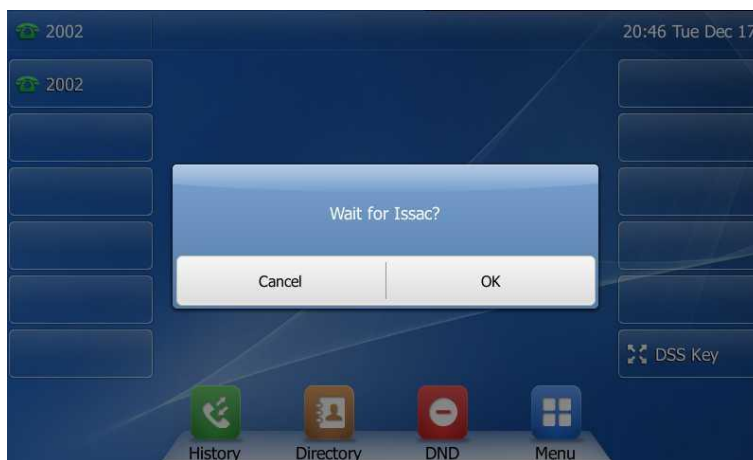

1. Tap the **OK** soft key, the phone returns to the idle screen and call completion is activated.

- When the called party becomes idle, the touch screen prompts the following:



- Tap the **OK** soft key to redial the number.

**Note** Call completion is not available on all servers. For more information, contact your system administrator.

## Call Return

You can tap a call return key to place a call back to the last incoming call.

**To configure a call return key via phone user interface:**

- Tap the **DSS Key** key.
- Tap the desired line key.
- Tap the gray box of the **Type** field.
- Tap **Key Event** from the pull-down list.
- Tap the gray box of the **Key Event** field.
- Tap **Call Return** from the pull-down list.
- (Optional.) Enter a label that will appear on the touch screen in the **Label** field.

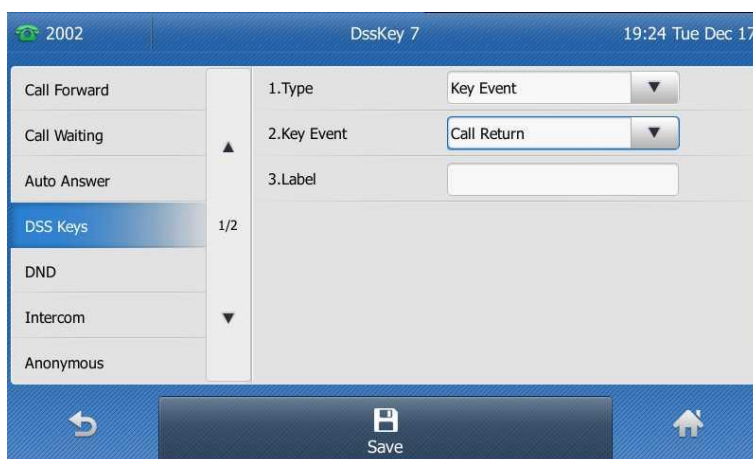



8. Tap the **Save** soft key to accept the change or  to cancel.
9. Tap the **DSS Key** key to return to the idle screen.

Call return key is configurable via web user interface at the path **DSSKey->Line key**.

## Call Mute

You can mute the microphone of the active audio device during an active call, and then the other party cannot hear you.

### To mute a call:

1. Press  during an active call.

The touch screen indicates that the call is on mute. The mute key LED illuminates solid red when the call is on mute.

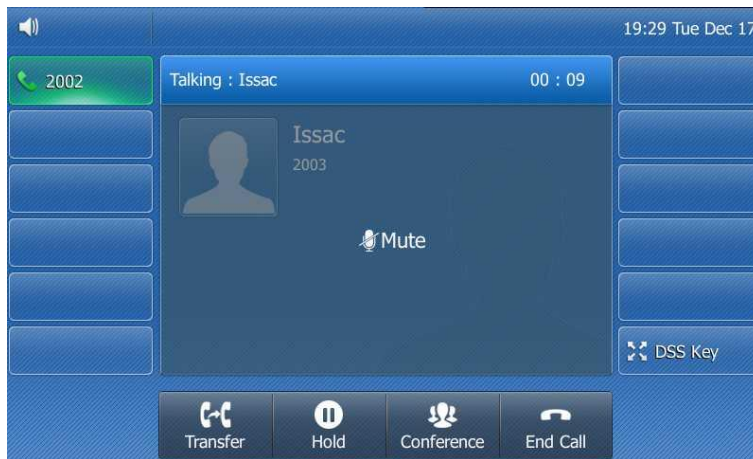

### To un-mute a call:

1. Press  again to un-mute the call.

## Call Hold/Resume

You can place an active call on hold. Only one active call can be in progress on the phone at any time. Other calls can be made and received while placing the original call on hold. When you place a call on hold, your IP PBX may play music on hold to the other party while waiting.

### To place a call on hold:

1. Press  or tap the **Hold** soft key during a call.



The touch screen indicates that the call is on hold.

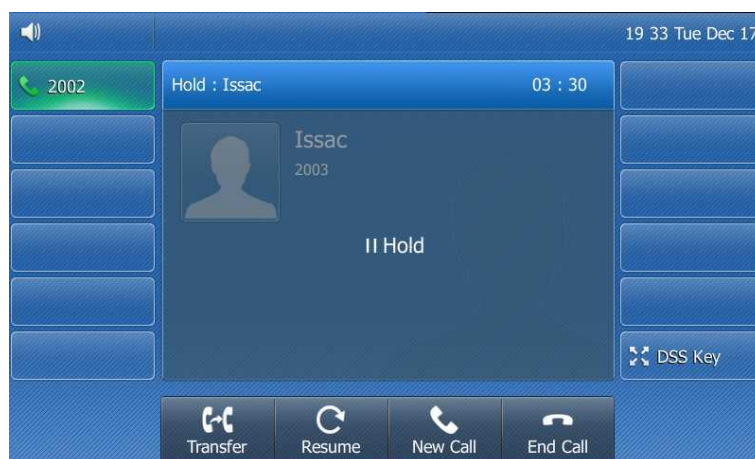

The phone will beep softly every 30 seconds to remind you that you still have a call on hold.

#### To resume a held call:

1. Press  or tap the **Resume** soft key.

#### Multiple Calls on Hold:

If multiple calls are placed on hold, do one of the following:

- Tap the desired call, and then tap the **Resume** soft key to retrieve it.
- Tap the desired call, and then tap the corresponding line key to retrieve it.

## Do Not Disturb (DND)

You can use DND to reject incoming calls automatically on the phone. Callers will receive a busy message.

You can enable/disable DND for the phone system, or you can customize DND for each or all accounts. Two DND modes:

- **Phone** (default): DND is effective for the phone system.
- **Custom**: DND can be configured for each or all accounts.

You can receive incoming calls from authorized numbers when DND is enabled.

#### To configure the DND mode via web user interface:

1. Click on **Features->Forward & DND**.

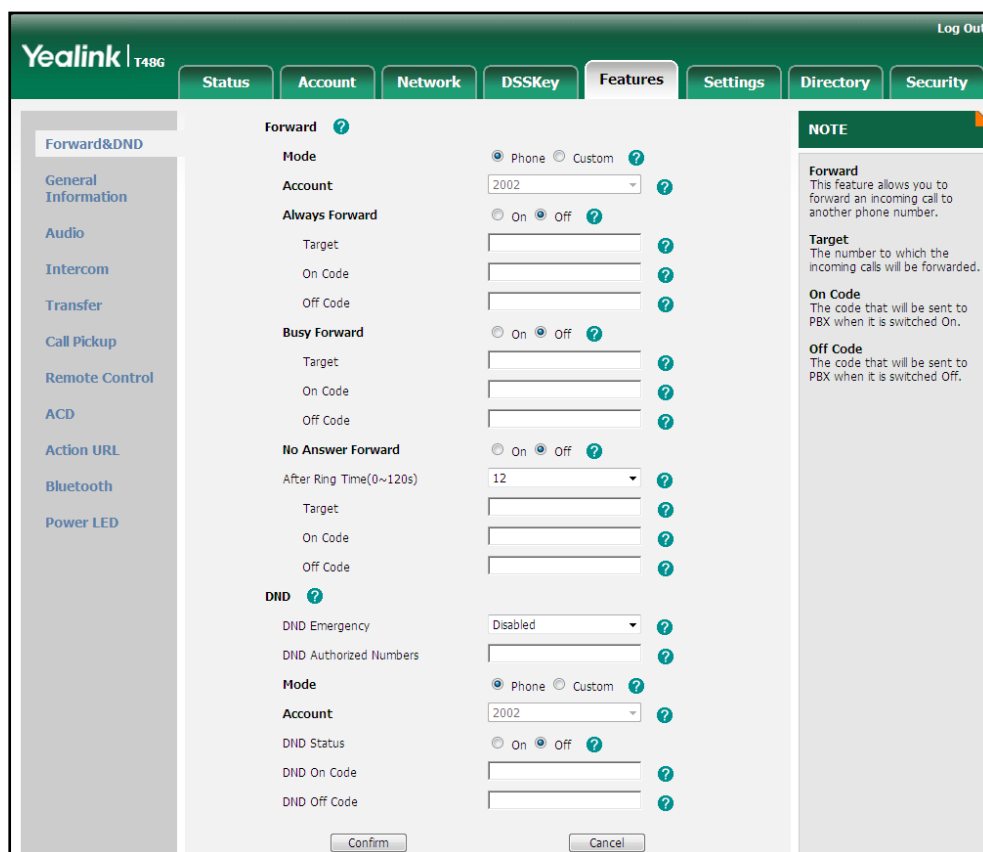

- In the **DND** block, mark the desired radio box in the **Mode** field.



- Click **Confirm** to accept the change.

**Note** DND mode is configurable via web user interface only.

**To activate DND in phone mode:**

- Tap  .  
The  icon on the status bar indicates that DND is enabled.

Incoming calls will be rejected automatically and "n New Missed Call(s)" ("n" indicates the number of the missed calls) will appear on the touch screen.

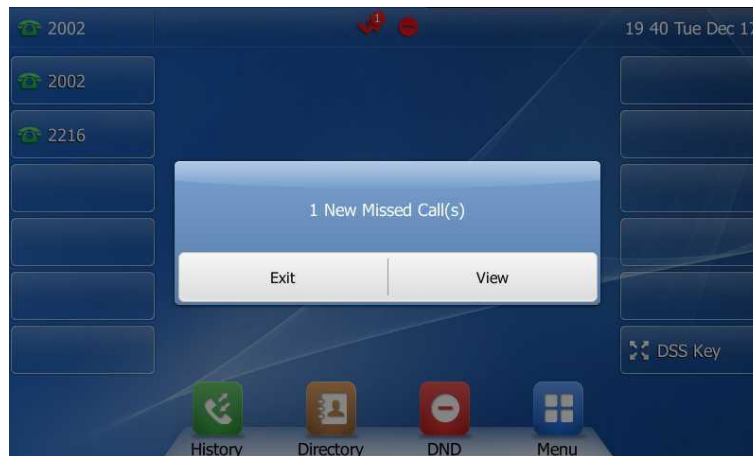

To activate DND in custom mode for a specific account:

1. Tap .



The touch screen displays a list of accounts registered on the phone.



2. Tap the desired account.
3. Tap the **On** radio box of the **Status** field.



4. Tap the **Save** soft key to accept the change.

The  icon appears on the status bar, and the associated line icon changes to .

Incoming calls on the specific line will be rejected automatically, and the touch screen will prompt "**n New Missed Call(s)**" ("n" indicates the number of the missed calls).



**To activate DND in custom mode for all accounts:**

1. Tap .

The touch screen displays a list of accounts registered on the phone.



2. Tap the **All On** soft key to activate DND for all accounts.

3. Tap  to return to the idle screen.

The  icon appears on the status bar, and all line icons change to .

Incoming calls will be rejected automatically, and the touch screen will prompt "**n New Missed Call(s)**" ("n" indicates the number of the missed calls).

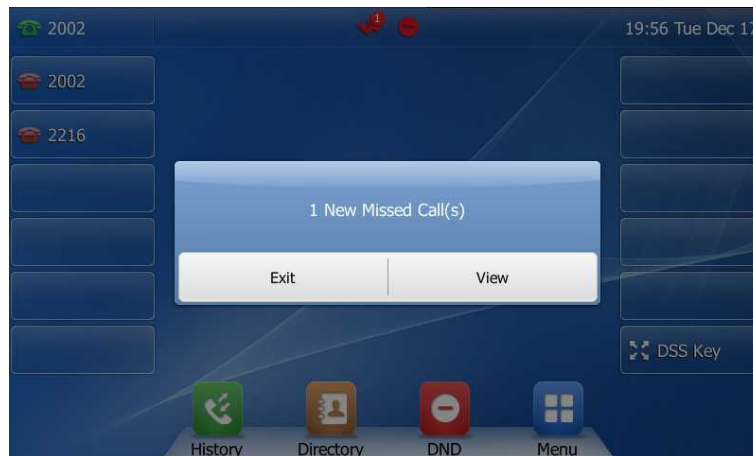
**Note**

The prompt message displays only if Missed Call Log for the line is enabled. Missed call log is configurable via web user interface at the path **Account->Basic**.

Do not disturb is local to the phone, and may be overridden by the server settings. For more information, contact your system administrator.

**To configure the DND authorized numbers via web user interface:**

1. Click on **Features->Forward & DND**.
2. Select **Enable** from the pull-down list of **DND Emergency**.
3. Enter the numbers in the **DND Authorized Numbers** field.

For multiple numbers, enter a comma between every two numbers.

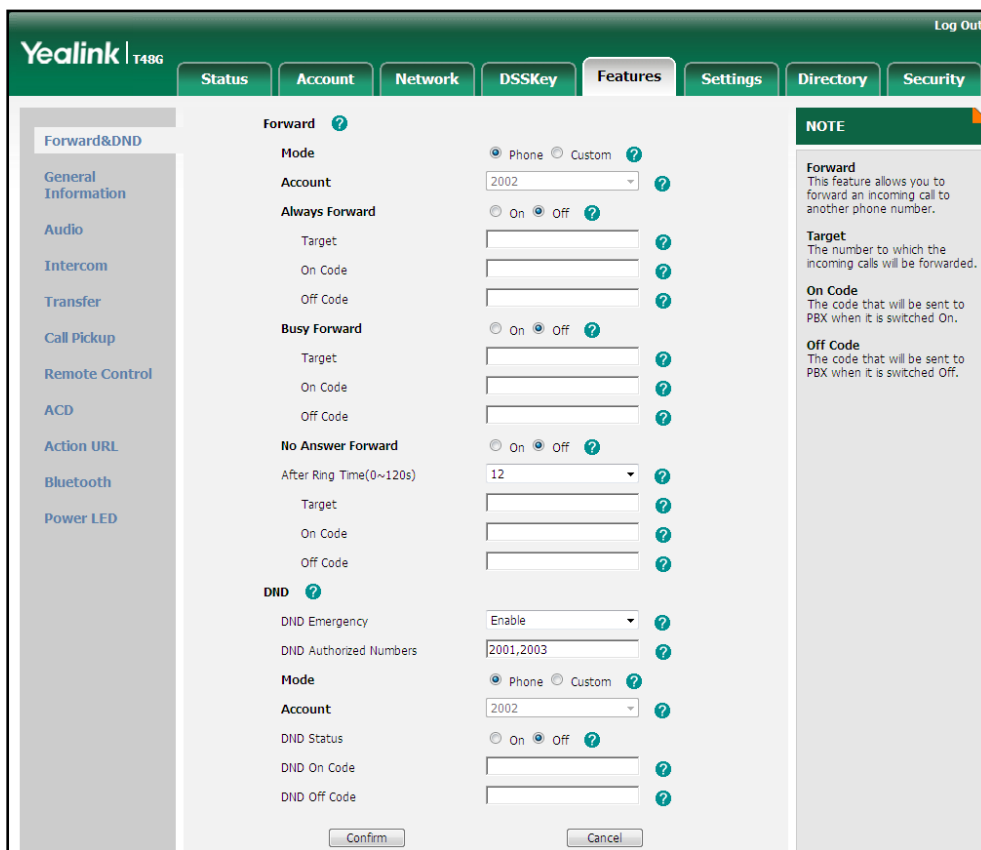

4. Click **Confirm** to accept the change.

When DND is enabled on the phone, the phone can still receive incoming calls from the numbers specified in the **DND Authorized Numbers** field.

**Note** DND authorized number is configurable via web user interface only.

## Call Forward

You can configure your phone to forward incoming calls to another party by the static forwarding. You can also forward calls while your phone is ringing, refer to the dynamic forwarding.

### Static Forwarding

Three types of static forwarding:

- **Always Forward:** Incoming calls are immediately forwarded.
- **Busy Forward:** Incoming calls are immediately forwarded if the phone is busy.
- **No Answer Forward:** Incoming calls are forwarded if not answered after a period of time.

You can enable/disable call forward for the phone system, or you can customize call forward for each or all accounts. Two call forward modes:

- **Phone** (default): Call forward is effective for the phone system.
- **Custom**: Call forward can be configured for each or all accounts.

To configure the call forward mode via web user interface:

1. Click on **Features**->**Forward & DND**.
2. In the **Forward** block, mark the desired radio box in the **Mode** field.

The screenshot shows the Yealink T49G web user interface. The top navigation bar includes Status, Account, Network, DSSKey, Features, Settings, Directory, and Security. The main content area is titled 'Forward & DND' and contains several configuration sections:

- Forward**: Mode (Phone selected), Account (2002), Always Forward (Off selected), Target, On Code, Off Code.
- Busy Forward**: Mode (Off selected), Target, On Code, Off Code.
- No Answer Forward**: Mode (Off selected), After Ring Time (0-120s) (12), Target, On Code, Off Code.
- DND**: DND Emergency (Disabled), DND Authorized Numbers, Mode (Phone selected), Account (2002), DND Status (Off selected), DND On Code, DND Off Code.



At the bottom, there are 'Confirm' and 'Cancel' buttons. A 'NOTE' section on the right explains the Forward feature and the codes used for switching On and Off.

3. Click **Confirm** to accept the change.

### Note

Call forward mode is configurable via web user interface only.

To enable call forward in phone mode:

1. Tap  -> **Call Features**->**Call Forward** or press  when the phone is idle.
2. Tap the desired forwarding type
3. Depending on your selection:
  - a.) If you tap **Always Forward**:
    - 1) Tap the **On** radio box of the **Always Forward** field.
    - 2) Enter the destination number you want to forward all incoming calls to in

the **Forward To** field.

- 3) (Optional.) Enter the always forward on code or off code respectively in the **On Code** or **Off Code** field.

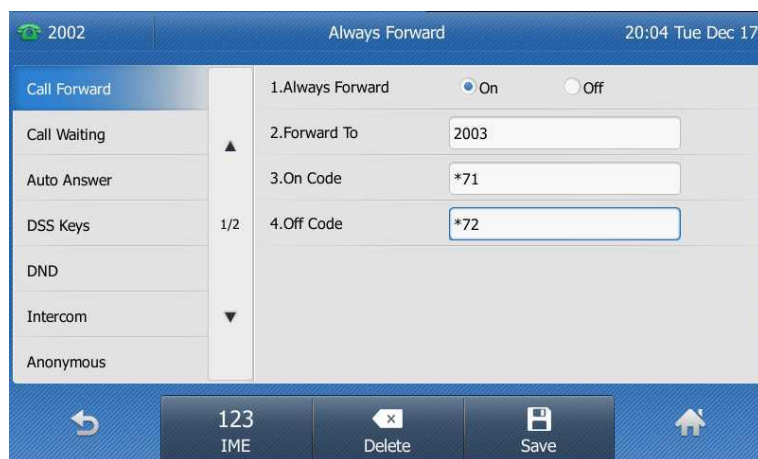

- b.) If you tap **Busy Forward**:

- 1) Tap the **On** radio box of the **Busy Forward** field.
- 2) Enter the destination number you want to forward incoming calls to when the phone is busy in the **Forward To** field.
- 3) (Optional.) Enter the busy forward on code or off code respectively in the **On Code** or **Off Code** field.

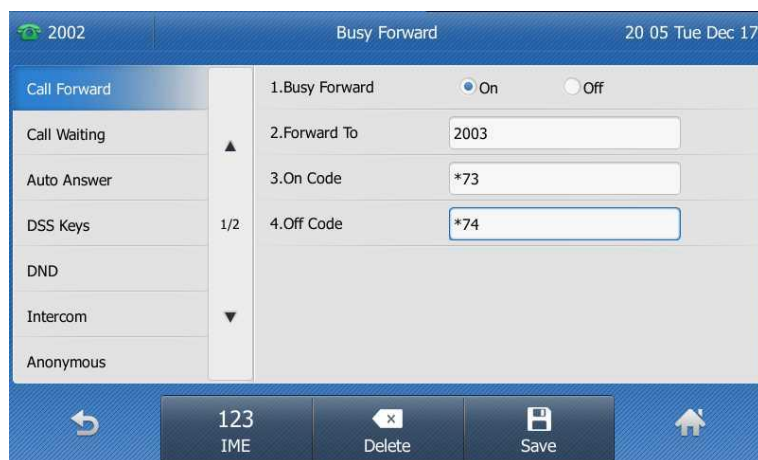

- c.) If you tap **No Answer Forward**:

- 1) Tap the **On** radio box of the **No Answer Forward** field.
- 2) Enter the destination number you want to forward unanswered incoming calls to in the **Forward To** field.
- 3) Tap the gray box of the **After Ring Time** field.
- 4) Tap the desired ring time to wait before forwarding from the pull-down list. The default ring time is 12 seconds.



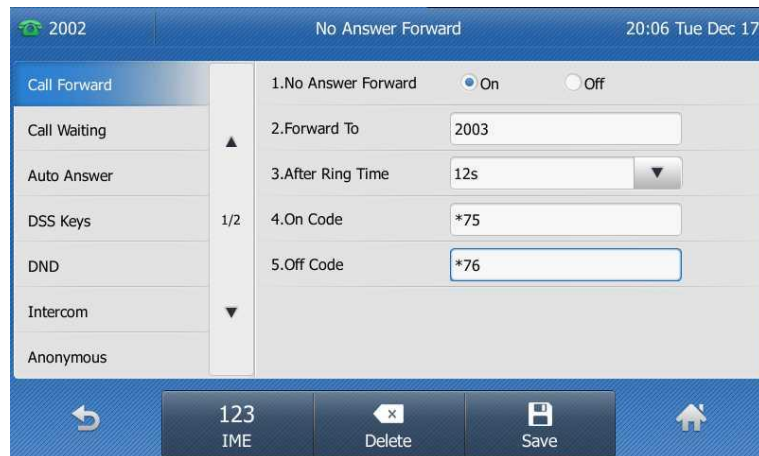

- 5) (Optional.) Enter the no answer forward on code or off code respectively in the **On Code** or **Off Code** field.



4. Tap the **Save** soft key to accept the change.

The  icon on the idle screen indicates the call forward is enabled.

#### To enable call forward in custom mode:

1. Tap  -> **Call Features**->**Call Forward** or press  when the phone is idle. The touch screen displays a list of accounts registered on the phone.
2. Tap the desired account.
3. Tap the desired forwarding type.
4. Depending on your selection:
  - a.) If you tap **Always Forward**:
    - 1) Tap the **On** radio box of the **Always Forward** field.
    - 2) Enter the destination number you want to forward all incoming calls to in the **Forward To** field.
    - 3) (Optional.) Enter the always forward on code or off code respectively in the **On Code** or **Off Code** field.

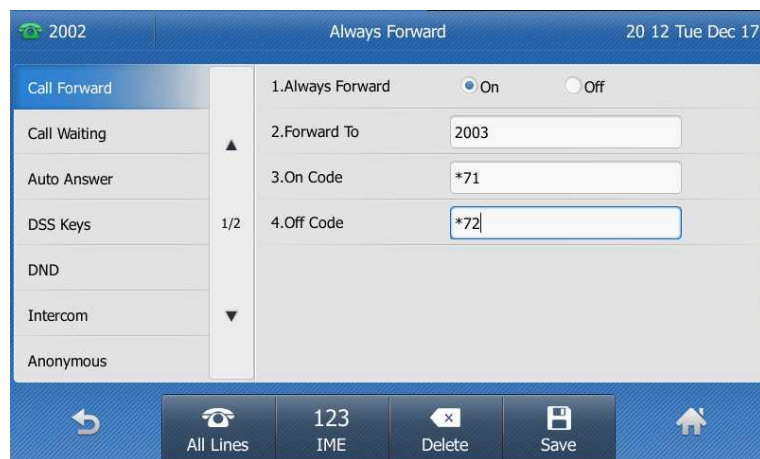

You can also enable always forward for all accounts. Do the following:

- 1) Tap the **All Lines** soft key.

The touch screen prompts “Copy to all lines?”.

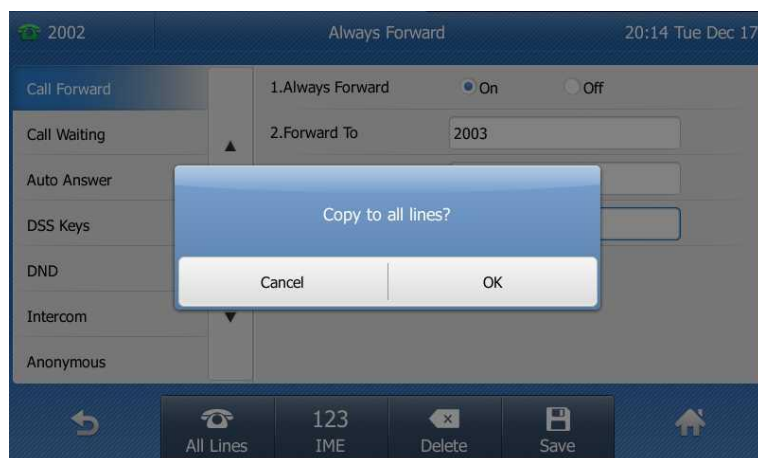

- 2) Tap the **OK** soft key to accept the change or the **Cancel** soft key to cancel.

b.) If you select **Busy Forward**:

- 1) Tap the **On** radio box of the **Busy Forward** field.
- 2) Enter the destination number you want to forward incoming calls to when the phone is busy in the **Forward To** field.
- 3) (Optional.) Enter the busy forward on code or off code respectively in the **On Code** or **Off Code** field.

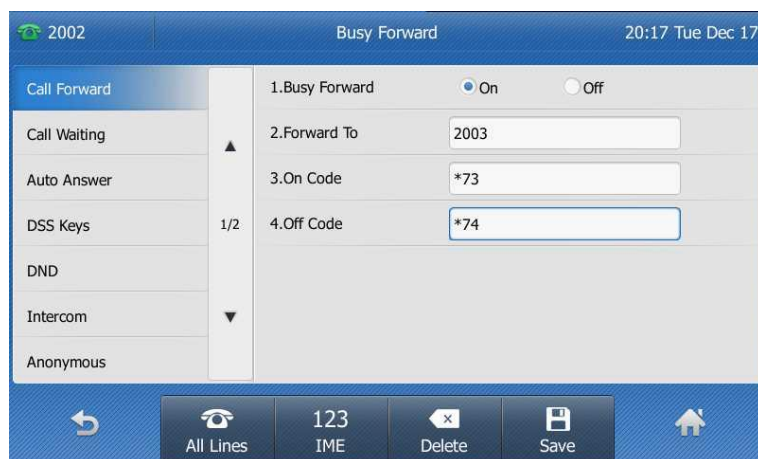

You can also enable busy forward for all accounts. Do the following:

- 1) Tap the **All Lines** soft key.

The touch screen prompts “Copy to all lines?”.

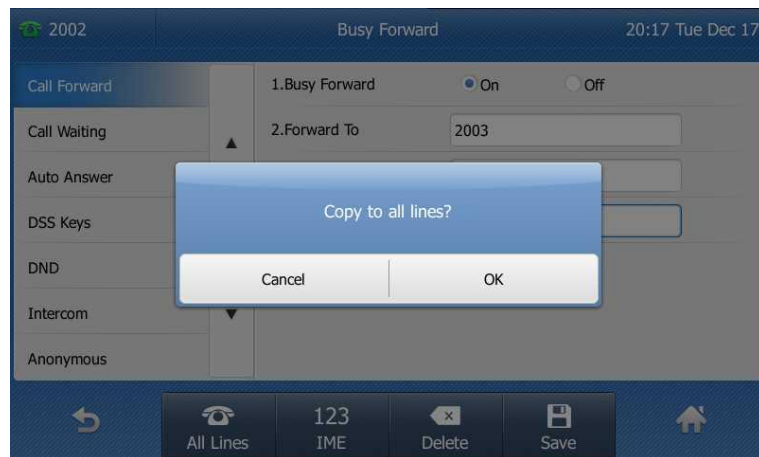

- 2) Tap the **OK** soft key to accept the change or the **Cancel** soft key to cancel.
- c.) If you select **No Answer Forward**:
- 1) Tap the **On** radio box of the **No Answer Forward** field.
  - 2) Enter the destination number you want to forward unanswered incoming calls to in the **Forward To** field.
  - 3) Tap the gray box of the **After Ring Time** field.
  - 4) Tap the desired ring time to wait before forwarding from the pull-down list.  
The default ring time is 12 seconds.
  - 5) (Optional.) Enter the no answer forward on code or off code respectively in the **On Code** or **Off Code** field.

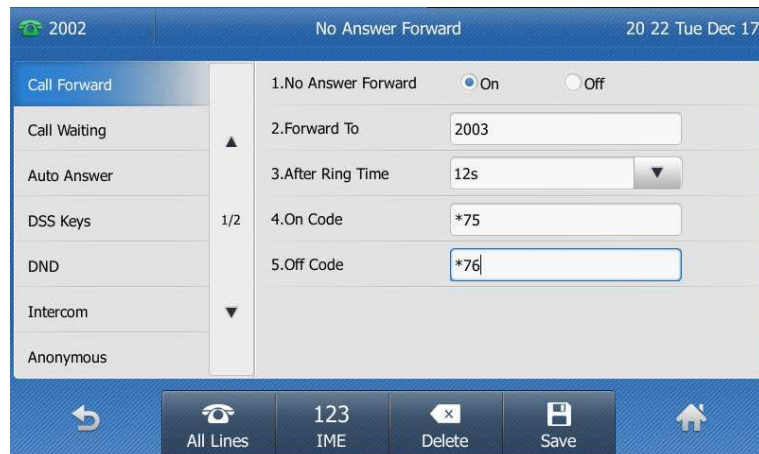

You can also enable no answer forward for all accounts. Do the following:

- 1) Tap the **All Lines** soft key.

The touch screen prompts “Copy to all lines?”.

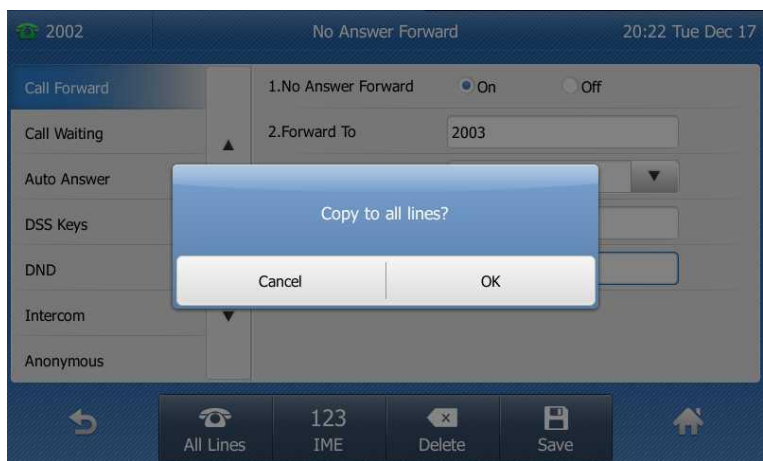

2) Tap the **OK** soft key to accept the change or the **Cancel** soft key to cancel.

5. Tap the **Save** soft key to accept the change.

The icon appears on the idle screen, and the associated line icon changes to .



Call forward is configurable via web user interface at the path **Features->Forward & DND**.

**Note**

You can also enter the SIP URL or IP address in the **Forward To** field. For more information on using the SIP URL or IP address, refer to [Placing Calls](#) on page 88.



Call forward is local to the phone, and may be overridden by the server settings. Call forward on code or off code may be different among servers. For more information, contact your system administrator.

**To disable call forward in phone mode:**

1. Tap ->**Call Features->Call Forward** or press when the phone is idle. You can tap the forward key to disable call forward when a forward key is configured.
2. Tap the desired forwarding type.

3. Tap the **Off** radio box.
4. Tap the **Save** soft key to accept the change.

**To disable call forward in custom mode for a specific account:**



1. Tap  -> **Call Features**->**Call Forward** or press  when the phone is idle.  
The touch screen displays a list of accounts registered on the phone.
2. Tap the desired account.
3. Tap the desired forwarding type.
4. Tap the **Off** radio box.
5. Tap the **Save** soft key to accept the change.

## Dynamic Forwarding

**To forward an incoming call to another party:**

1. When the phone is ringing, tap the **Forward** soft key.
2. Enter the number you want to forward the incoming call to.



3. Press  ,  , or tap the **Send** soft key.  
The touch screen prompts a call forward message.

## Call Transfer

You can transfer a call to another party in one of the three ways:

- **Blind Transfer:** Transfer a call directly to another party without consulting.
- **Semi-Attended Transfer:** Transfer a call when the target phone is ringing.
- **Attended Transfer:** Transfer a call with prior consulting.

**To perform a blind transfer:**



1. Press  or tap the **Transfer** soft key during a call.

2. Enter the number you want to transfer the call to.





3. Press  or tap the **Transfer** soft key to complete the transfer.  
Then the call is connected to the number to which you are transferring.

**To perform a semi-attended transfer:**

1. Press  or tap the **Transfer** soft key during a call.
2. Do one of the following:
  - Enter the number you want to transfer the call to.
  - Tap the **Directory** soft key, and then tap the desired directory list. Tap the desired contact to dial out.
  - Tap the **History** soft key, and then tap the desired list. Tap the desired entry to dial out.
3. Press  or tap the **Transfer** soft key to complete the transfer when receiving ringback.

**To perform an attended transfer:**

1. Press  or tap the **Transfer** soft key during a call.
2. Do one of the following:
  - Enter the number you want to transfer the call to.
  - Tap the **Directory** soft key, and then tap the desired directory list. Tap the desired contact to dial out.
  - Tap the **History** soft key, and then tap the desired list. Tap the desired entry to dial out.
3. After the party answers the call, press  or tap the **Transfer** soft key to complete the transfer.

If you are using a handset, the transfer can be completed by hanging up the handset.

## Call Waiting

You can enable or disable call waiting on the phone. If call waiting is enabled, you can receive another call when there is an active call on the phone. Otherwise, another incoming call is automatically rejected by the phone with a busy message when there is an active call on the phone. You can also enable or disable the phone to play a warning tone when receiving another call.

**To configure call waiting via phone user interface:**

1. Tap  -> **Call Features**->**Call Waiting**.
2. Tap the **On** radio box of the **Call Waiting** field.
3. Tap the **On** radio box of the **Play Tone** field.
4. (Optional.) Enter the call waiting on code or off code respectively in the **On Code** or **Off Code** field.



5. Tap the **Save** soft key to accept the change or  to cancel.

Call waiting is configurable via web user interface at the path **Features->General Information**.

## Conference

You can use SIP-T48G IP phone to create a conference with two parties using the phone's local conference or create a conference with multiple participants called network conference.

### Note

Network conference is not available on all servers. For more information, contact your system administrator.



## Local Conference

The SIP-T48G IP phone supports up to 3 parties (including yourself) in a conference call. This is the default method of conference called Local Conference.

### To set up a local conference call:

1. Place a call to the first party.
2. When the first party answers the call, tap the **Conference** soft key to place a new call.

The active call is placed on hold.

3. Enter the number of the second party, and then press **OK** , **#SEND** , or tap the **Send** soft key.
4. When the second party answers the call, tap the **Conference** soft key again to join all parties in the conference.



You can create a conference between an active call and a call on hold by tapping the **Conference** soft key.

### To join two calls in a conference:





1. Place two calls using two different accounts on the phone (for example, place the first call using account 1, and then place the second call using account 2).
2. Tap the desired call for conference and make sure the call is active (for example, tap the call on account 1).

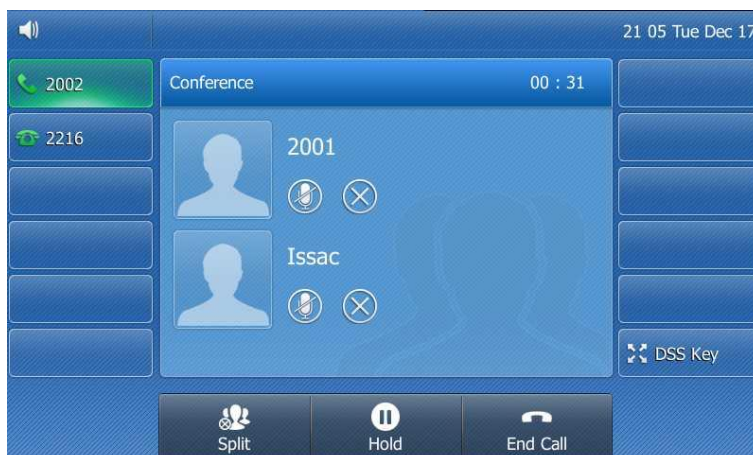

3. Tap the **Conference** soft key to join the two calls in the conference on the selected account.



During the conference call, you can do the following:

- Press  or tap the **Hold** soft key to place the conference call on hold.
- Tap the **Split** soft key to split the conference call into two individual calls.
- Tap  to remove the desired party.
- Press  or tap  to mute the conference call.
- Tap the **End Call** soft key to drop the conference call.

## Network Conference

You can use network conference feature on the SIP-T48G IP phone to conduct a conference with multiple participants.

This feature allows you to perform the following:

- Join two calls together into a conference call.
- Invite another party into an active conference call.

To use this feature, contact your system administrator for the network conference URI in advance.

**To configure network conference via web user interface:**

1. Click on **Account->Advanced**.
2. Select **Network Conference** from the pull-down list of **Conference Type**.

- Enter the conference URI (e.g., conference@example.com) in the **Conference URI** field.

The screenshot shows the Yealink T48G web interface with the 'Account' tab selected. The 'Advanced' sub-tab is active, displaying various configuration options. The 'Conference URI' field is highlighted, containing the text 'conference@example.com'. Other visible fields include 'Keep Alive Type' (Default), 'Keep Alive Interval(Seconds)' (30), 'Local SIP Port' (5062), 'RPort' (Disabled), and several 'SIP Session Timer' fields. A 'NOTE' box on the right side of the page states: 'Advanced: The Advanced parameters for administrator.'

- Click **Confirm** to accept the change.

#### Note

Network conference is configurable via web user interface only.

#### To set up a network conference call:

- Place a call to the first party.
- Tap the **Conference** soft key to place a new call.  
The active call is placed on hold.
- Enter the number of the second party and press **OK** , **#SEND** , or tap the **Send** soft key.
- When the second party answers the call, tap the **Conference** soft key to add the second party to the conference.
- Tap the **Conference** soft key to place a new call.  
The conference call is placed on hold.
- Enter the number of the new party and then press **OK** , **#SEND** , or tap the **Send** soft key.
- When the new party answers the call, tap the **Conference** soft key to add the new party to the conference.
- Repeat steps 5 to 7 until you have added all intended parties.

The procedures to set up a network conference call on specific servers may be different from introduced above. Contact your system administrator for more information.

## Call Park

You can use call park to place a call on hold, and then retrieve the call from another phone in the system (for example, a phone in another office or conference room). You can park an active call by tapping the call park key on the phone. If the call is parked successfully, the response is either a voice prompt confirming that the call was parked, or a visible prompt on the touch screen.

### Note

Call park is not available on all servers. Contact your system administrator for more information.

#### To configure a call park key via phone user interface:

1. Tap the **DSS Key** key.
2. Tap the desired line key.
3. Tap the gray box of the **Type** field.
4. Tap **Key Event** from the pull-down list.
5. Tap the gray box of the **Key Event** field.
6. Tap **Call Park** from the pull-down list.
7. Tap the gray box of the **Account ID** field.
8. Tap the desired line from pull-down list.
9. (Optional.) Enter the string that will appear on the touch screen in the **Label** field.
10. Enter the call park code in the **Value** field.



11. Tap the **Save** soft key to accept the change or  to cancel.
12. Tap the **DSS Key** key to return to the idle screen.

Call park key is configurable via web user interface at the path **DSSKey->Line Key**.

#### To use call park:

1. User on phone A places a call to phone B.

2. User on phone A wants to take the call in a conference room for privacy, then tap the call park key on phone A.
3. User on phone A walks to an available conference room where the phone is designated as phone C. The user dials the call park retrieve code to retrieve the parked call.

The system establishes call between phone C and B.

**Note**

The call park code and call park retrieve code are predefined on the system server. Contact your system administrator for more information.

If the parked call is not retrieved within a period of time assigned by the system, the phone performing call park feature will receive call back.

## Call Pickup

You can use call pickup to answer someone else's incoming call on the phone. The SIP-T48G IP phone supports directed call pickup and group call pickup. Directed call pickup is used for picking up a call that is ringing at a specific phone number. Group call pickup is used for picking up a call that is ringing at any phone number in the group. The pickup group should be predefined, contact your system administrator for more information.

You can pick up an incoming call by using the DPickup/GPickup soft key. To use call pickup, you need to configure the call pickup code beforehand on a global or per-line basis via web user interface. The call pickup code configured on a per-line basis takes precedence over that configured on a global basis.

**Note**

If there are many incoming calls at the same time, pressing the **GPickup** soft key on the phone will pick up the call that rings first.

### Directed Call Pickup

**To enable directed call pickup and configure the directed call pickup code on a global basis via web user interface:**

1. Click on **Features->Call Pickup**.
2. Select **Enabled** from the pull-down list of **Directed Call Pickup**.

- Enter the directed call pickup code in the **Directed Call Pickup Code** field.

The screenshot shows the 'Call Pickup' configuration page in the Yealink T48G web interface. The 'Features' tab is selected. The configuration includes the following fields:

Field	Value
Directed Call Pickup	Enabled
Directed Call Pickup Code	*97
Group Call Pickup	Disabled
Group Call Pickup Code	
Visual Alert: for BLF Pickup	Disabled
Audio Alert: for BLF Pickup	Disabled

Buttons for 'Confirm' and 'Cancel' are visible at the bottom of the configuration area. A 'NOTE' box on the right states: 'Call Pickup: The call pickup parameters for administrator.'

- Click **Confirm** to accept the change.

To configure the directed call pickup code on a per-line basis via web user interface:

- Click on **Account**.
- Select the desired account from the pull-down list of **Account**.
- Click on **Advanced**.
- Enter the directed call pickup code in the **Directed Call Pickup Code** field.

The screenshot shows the 'Advanced' configuration page for 'Account 1' in the Yealink T48G web interface. The 'Account' tab is selected. The configuration includes the following fields:

Field	Value
Account	Account 1
Keep Alive Type	Default
Keep Alive Interval(Seconds)	30
Local SIP Port	5062
RPort	Disabled
SIP Session Timer T1 (0.5~10s)	0.5
SIP Session Timer T2 (2~40s)	4
SIP Session Timer T4 (2.5~60s)	5
Early Media	Disabled
SIP Server Type	Default
Music Server URI	
Directed Call Pickup Code	*97
Group Call Pickup Code	
Distinctive Ring Tones	Disabled
Unregister When Reboot	Disabled
Out Dialog BLF	Disabled

Buttons for 'Confirm' and 'Cancel' are visible at the bottom of the configuration area. A 'NOTE' box on the right states: 'Advanced: The Advanced parameters for administrator.'

- Click **Confirm** to accept the change.

To pick up a call directly:

- Pick up the handset or tap the line key.

The **DPickup** soft key appears on the on-screen keypad.



2. Tap the **DPickup** soft key on your phone when a phone receives an incoming call.
3. Enter the phone number which receives an incoming call.
4. Tap the **DPickup** soft key again.

The call is answered on your phone.

You can also configure a line key as a directed pickup key via phone user interface or web user interface. You can pick up a call by tapping the directed pickup key directly. For more information, refer to [Line Keys](#) on page 67.

## Group Call Pickup

To enable the group call pickup and configure the group call pickup code on a global basis via web user interface:

1. Click on **Features->Call Pickup**.
2. Select **Enabled** from the pull-down list of **Group Call Pickup**.
3. Enter the group call pickup code in the **Group Call Pickup Code** field.

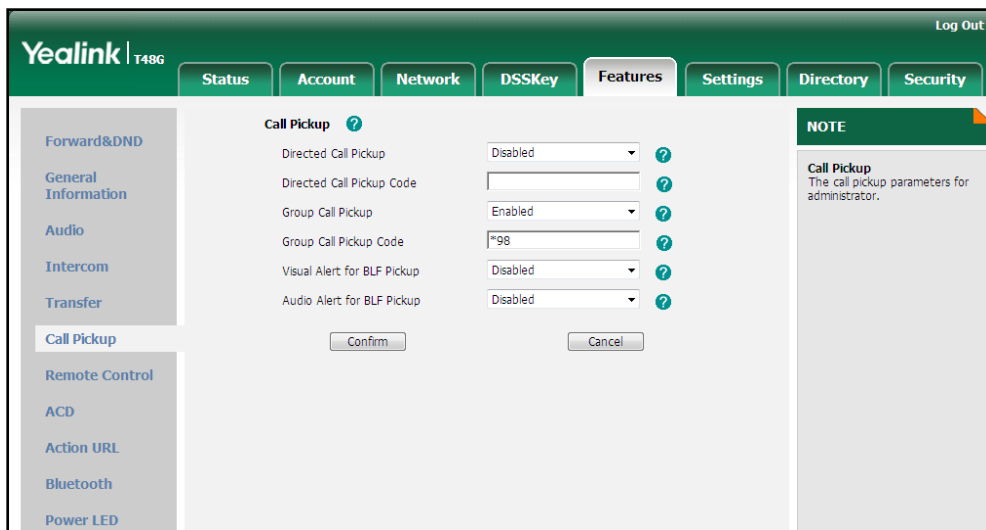

4. Click **Confirm** to accept the change.

To configure the group call pickup code on a per-line basis via web user interface:

1. Click on **Account**.
2. Select the desired account from the pull-down list of **Account**.
3. Click on **Advanced**.
4. Enter the group call pickup code in the **Group Call Pickup Code** field.

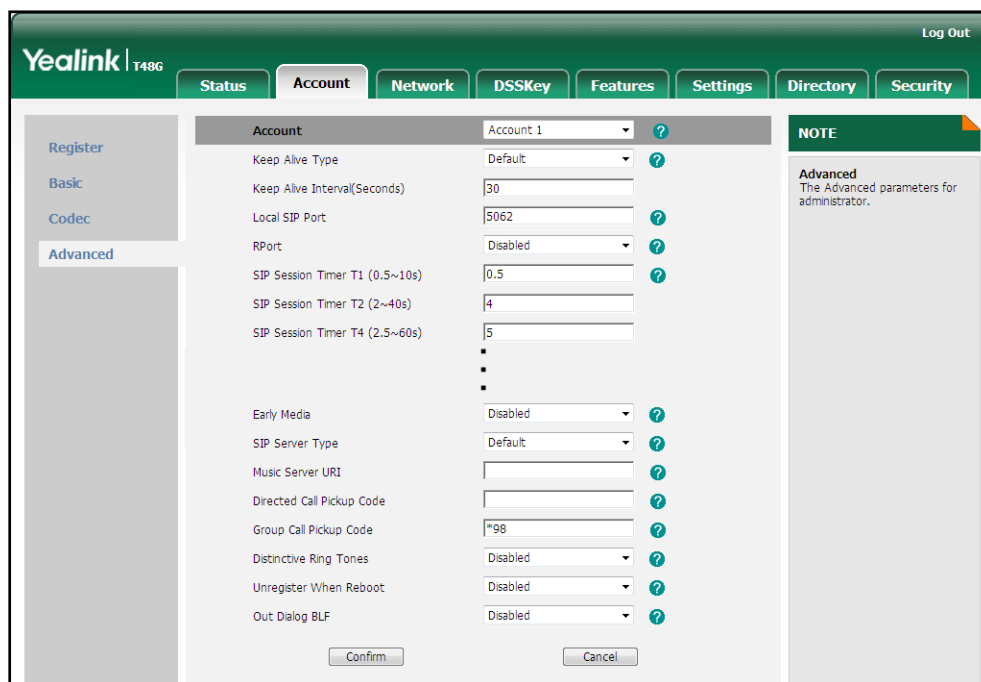

5. Click **Confirm** to accept the change.

To pick up a call in the group:

1. Pick up the handset or tap the line key.

The **GPickup** soft key appears on the on-screen keypad.



2. Tap the **GPickup** soft key on your phone when a phone in the group receives an incoming call.

The call is answered on your phone.

You can also configure a line key as a group pickup key via phone user interface or web user interface. You can pick up a call by tapping the group pickup key directly.

**Note**

The directed call pickup code and group call pickup code are predefined on the system server. Contact your system administrator for more information.

## Anonymous Call

You can use anonymous call to block the identity and phone number from showing up to the called party when you call someone. For example, you want to call to consult some of the services, but don't want to be harassed. Anonymous call is configurable on a per-line basis. You can also configure the phone to send anonymous code to the server to activate/deactivate anonymous call on the server side.

**Note**

Anonymous call is not available on all servers. Contact your system administrator for the anonymous call on code and off code.

To configure anonymous call via phone user interface:

1. Tap  -> **Call Features**->**Anonymous**.
2. Tap the desired line.
3. Tap the **On** radio box of the **Local Anonymous** field.
4. (Optional.) Tap the **On Code** or **Off Code** radio box of the **Send Anonymous Code** field.
5. (Optional.) Enter the anonymous call on code in the **On Code** field.
6. (Optional.) Enter the anonymous call off code in the **Off Code** field.

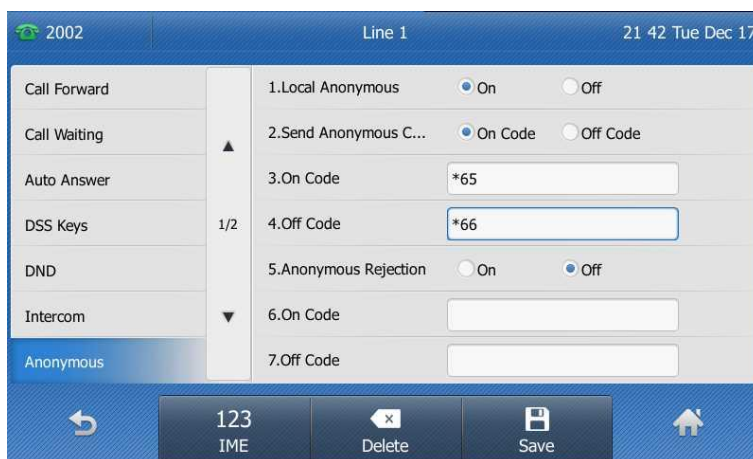

7. Tap the **Save** soft key to accept the change or  to cancel.

Anonymous call is configurable via web user interface at the path **Account->Basic**.



**To place an anonymous call:**

- Using the specific line on the phone to place a call to phone B.

The touch screen of phone B prompts an incoming call from anonymity.





## Anonymous Call Rejection

You can use anonymous call rejection to reject incoming calls from anonymous callers. Anonymous call rejection automatically rejects incoming calls from callers who deliberately block their identities and numbers from showing up. Anonymous call rejection is configurable on a per-line basis.

**To configure anonymous call rejection via phone user interface:**

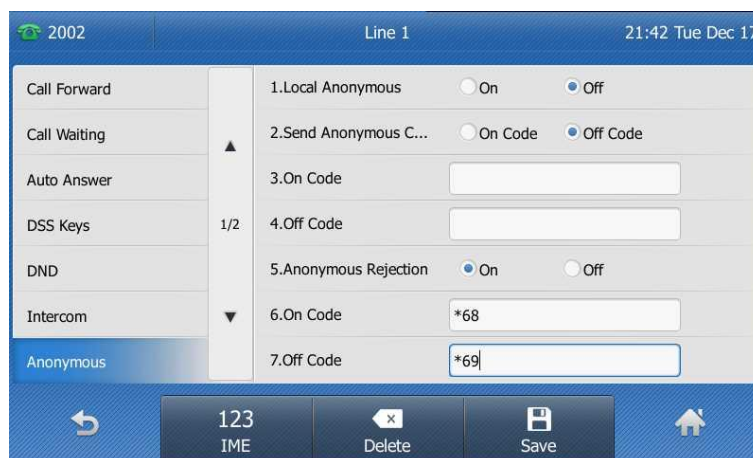
- Tap  -> **Call Features**->**Anonymous**.
- Tap the desired line.
- Tap the **On** radio box of the **Anonymous Rejection** field.
- (Optional.) Enter the anonymous call rejection on code in the **On Code** field.
- (Optional.) Enter the anonymous call rejection off code in the **Off Code** field.



- Tap the **Save** soft key to accept the change or  to cancel.

Anonymous call rejection is configurable via web user interface at the path **Account->Basic**.

When the phone B with anonymous call feature enabled places a call to your phone, the call will be rejected, and the touch screen of the phone B will prompts the following:



# Advanced Phone Features

---

This chapter provides operating instructions for the advanced features of the SIP-T48G IP phone. Topics include:

- [Busy Lamp Field \(BLF\)](#)
- [Call Recording](#)
- [Hot Desking](#)
- [Intercom](#)
- [Multicast Paging](#)
- [Music on Hold](#)
- [Messages](#)

If you require additional information or assistance with your new phone, contact your system administrator.

## Busy Lamp Field (BLF)

You can use BLF to monitor a specific line for status changes on the phone. For example, you can configure a BLF key on the phone for monitoring the status of a friend's line (busy or idle). The BLF key illuminates solid red when the friend's line is in use.

You can tap a BLF key to dial out the monitored phone number when the monitored line is idle. You can receive a visual and an audio alert (if enabled), and also pick up the call when the monitored line receives an incoming call. For more information, contact your system administrator.

### To configure a BLF key via phone user interface:

1. Tap the **DSS Key** key.
2. Tap the desired line key.
3. Tap the gray box of the **Type** field.
4. Tap **BLF** from the pull-down list.
5. Tap the gray box of the **Account ID** field.
6. Tap the desired line from the pull-down list.
7. (Optional.) Enter the string that will appear on the touch screen in the **Label** field.
8. Enter the phone number or extension you want to monitor in the **Value** field.

- (Optional.) Enter the pickup code in the **Extension** field.

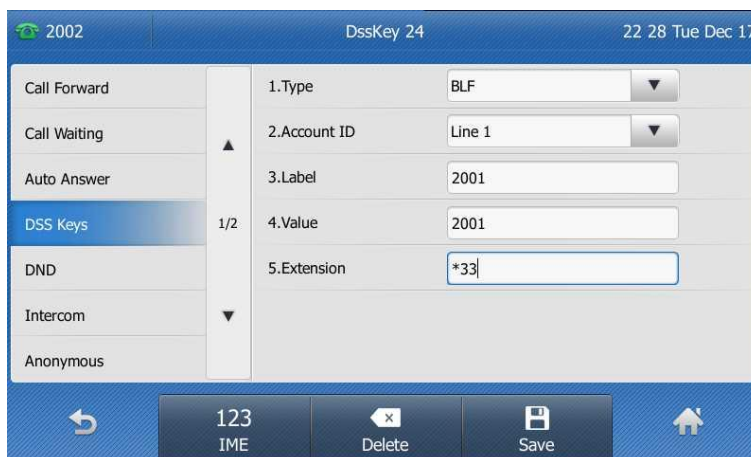

- Tap the **Save** soft key to accept the change or to cancel.

- Tap the **DSS Key** key to return to the idle screen.

BLF key is configurable via web user interface at the path **DSSKey->Line key**.

The following table lists the BLF key icon status:

Status of the BLF Key Icon	Status of the Monitored User
	The monitored user is idle.
(flashing)	The monitored user places a call to another user.
(flashing)	The monitored user receives an incoming intercom call.
	The monitored user is during an active call.
	The call of the monitored user is parked.
	The monitored user does not exist.

You can enable audio alert for BLF pickup on the phone. This allows the monitoring phone to play a warning tone when the monitored line receives an incoming call. You can also enable visual alert for BLF pickup on the phone. This allows the touch screen of the monitoring phone to display the caller ID when the monitored line receives an incoming call.

**To enable visual and audio alert via web user interface:**

- Click on **Features->Call Pickup**.
- Select **Enabled** from the pull-down list of **Visual Alert for BLF Pickup**.

3. Select **Enabled** from the pull-down list of **Audio Alert for BLF Pickup**.

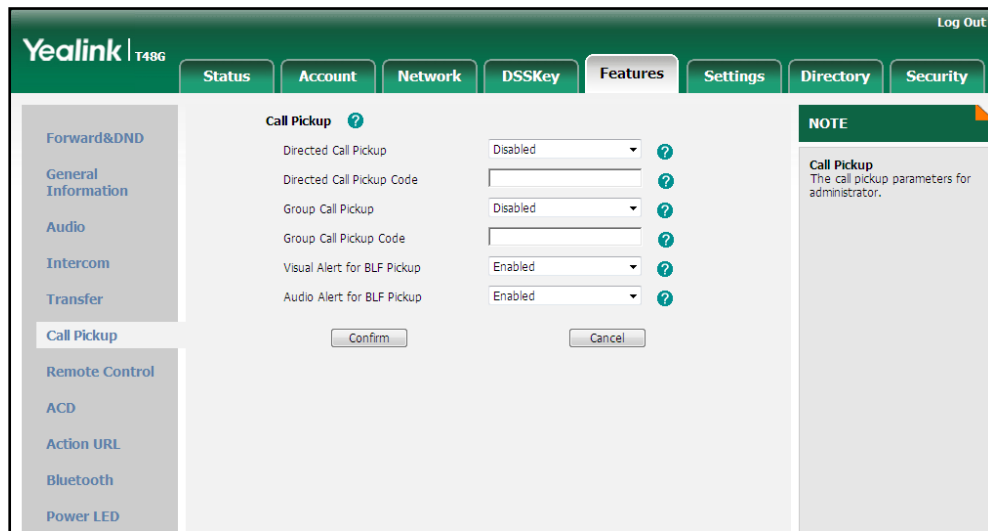

4. Click **Confirm** to accept the change.

**Note**

Visual and audio alerts are configurable via web user interface only.

When the monitored line receives an incoming call, the followings occur on the phone:

- The phone plays a warning tone (if enabled).
- The BLF key icon illuminates red and flashes.
- The caller ID appears on the touch screen (if enabled).

In the following figure, the touch screen shows an incoming call from 2003 on the monitored line.



When there is an active call on the IP phone, you can transfer the active call to the monitored phone number directly by tapping the BLF key. The phone transfers the active call differently depending on the transfer mode via DSS key. For more information on performing call transfer, refer to [Call Transfer](#) on page 111.

To configure the transfer mode via DSS key via web user interface:

1. Click on **Features->Transfer**.
2. Select the desired transfer mode from the pull-down list of **Transfer Mode Via Dsskey**. Depending on your selection:
  - If you select **Blind Transfer**, tap the BLF key to blind transfer the call to the monitored phone number.
  - If you select **Attended Transfer**, tap the BLF key to dial out the monitored phone number. Then you can perform the attended or semi-attended transfer.
  - If you select **New Call**, tap the BLF key to place a new call to the monitored user.

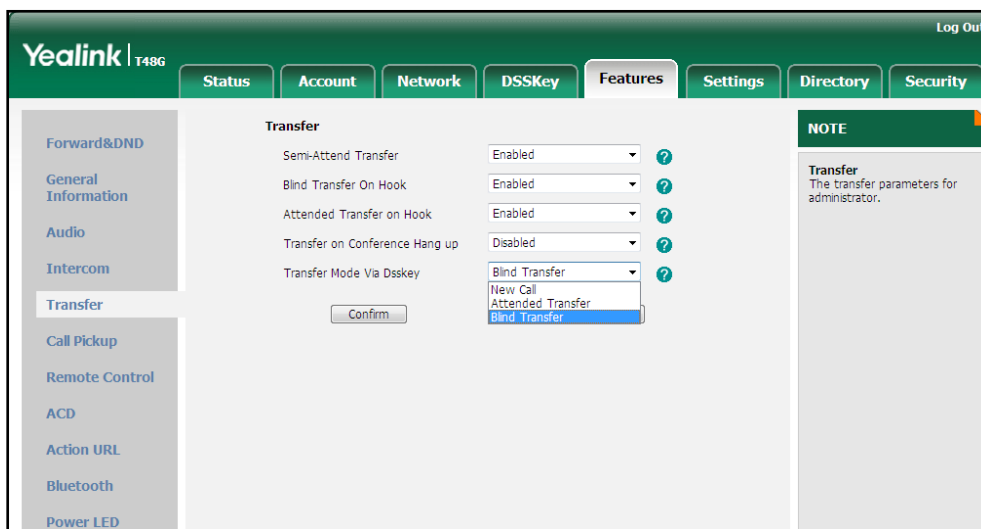

3. Click **Confirm** to accept the change.

**Note** Transfer mode via DSS key is configurable via web user interface only.

## Call Recording

You can record calls by tapping a record key on the phone. The SIP-T48G IP phone supports record and URL record.

Two ways of call recording:

- **Record:** The phone sends a SIP INFO message containing a specific header “Record: on/off” to trigger a recording.
- **URL Record:** The phone sends an HTTP URL request to trigger a recording. Contact your system administrator for the predefined URL.

**Note** Call record is not available on all servers. Contact your system administrator for more information.

**To configure a record key via phone user interface:**

1. Tap the **DSS Key** key.
2. Tap the desired line key.
3. Tap the gray box of the **Type** field.
4. Tap **Key Event** from the pull-down list.
5. Tap the gray box of the **Key Event** field.
6. Tap **Record** from the pull-down list.
7. (Optional.) Enter a label that will appear on the touch screen in the **Label** field.

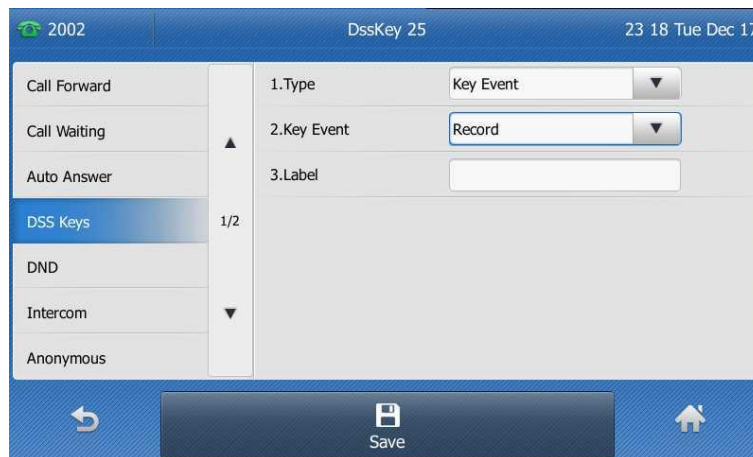

8. Tap the **Save** soft key to accept the change or  to cancel.
9. Tap the **DSS Key** key to return to the idle screen.

**To configure a URL record key via phone user interface:**

1. Tap the **DSS Key** key.
2. Tap the desired line key.
3. Tap the gray box of the **Type** field.
4. Tap **URL Record** from the pull-down list.
5. (Optional.) Enter a label that will appear on the touch screen in the **Label** field.
6. Enter the URL (e.g., `http://10.1.2.224/phonerecording.cgi`) in the **URL Record** field.



7. Tap the **Save** soft key to accept the change or  to cancel.
8. Tap the **DSS Key** key to return to the idle screen.

Record and URL record key are configurable via web user interface at the path **DSSKey->Line Key**.



**The Record and URL Record keys control the recording, and are available:**

- During an active call
- When calls are on hold or mute
- During a blind or attended transfer
- During a conference call
- When the phone prompts you to answer an incoming call





**The Record and URL Record keys are not available when:**

- There is no connected calls on your phone
- You place a new call

**To record a call:**

1. Tap the Record key or URL Record key during a call.  
If the recording starts successfully, the recording icon will appear on the touch screen and the icon of the Record key or URL Record key changes to .
2. Tap the Record key or URL Record key again to stop recording.  
The recording icon disappears from the touch screen and the icon of the Record key or URL Record key changes to .

Recording status indications you need to know:

Circumstance	Icons on the touch screen
A recording is started	 appears on the touch screen
A recording cannot be started	 appears for 1 second
A recording cannot be stopped	 appears for 1 second, then goes back
The recording box is full	 appears for 1 second
The call cannot be recorded	 appears for 1 second

You can listen to the recordings stored on your server system. For example, you can dial an access code to listen to the recordings.

**Note**

The way in which you listen to the recordings may be different on different servers. Contact your system administrator for more information.



## Hot Desking

Hot desking originates from the definition of being the temporary physical occupant of a work station or surface by a particular employee. A primary motivation for hot desking is cost reduction. This feature is regularly used in places where not all the employees are in the office at the same time, or not in the office for very long at all, which means actual personal offices would be often vacant, consuming valuable space and resources.

You can use hot desking on the SIP-T48G IP phone to log out of the existing accounts and then log into a new account. As a result, many users can share the phone resource in different time. To use this feature, you need to configure a hot desking key in advance.

### Note

Hot desking is not available on all servers. Contact your system administrator for more information.

#### To configure a hot desking key via phone user interface:

1. Tap the **DSS Key** key.
2. Tap the desired line key.
3. Tap the gray box of the **Type** field.
4. Tap **Key Event** from the pull-down list.
5. Tap the gray box of the **Key Event** field.
6. Tap **Hot Desking** from the pull-down list.
7. (Optional.) Enter a label that will appear on the touch screen in the **Label** field.



8. Tap the **Save** soft key to accept the change or  to cancel.
9. Tap the **DSS Key** key to return to the idle screen.

Hot desking key is configurable via web user interface at the path **DSSKey->Line Key**.

**To use hot desking:**

1. Tap the **Hot Desking** key when the phone is idle.

The touch screen prompts the following warning:



2. Tap the **OK** soft key.

Registration configurations of all accounts on the phone will be cleared immediately.

The login wizard will be shown as below:



3. Enter the login information in each field.
4. Tap the **Save** soft key to login or  to cancel.

## Intercom

Intercom is a useful feature in an office environment to quickly connect with the operator or the secretary. You can tap the intercom key to automatically connect with a remote extension for outgoing intercom calls, and the remote extension will automatically answer the incoming intercom calls.

### Note

Intercom is not available on all servers. Contact your system administrator for more information.

## Outgoing Intercom Calls

To configure an intercom key via phone user interface:

1. Tap the **DSS Key** key.
2. Tap the desired line key.
3. Tap the gray box of the **Type** field.
4. Tap **Intercom** from the pull-down list.
5. Tap the gray box of the **Account ID** field.
6. Tap the desired line from the pull-down list.
7. (Optional.) Enter the string that will appear on the touch screen in the **Label** field.
8. Enter the remote extension number in the **Value** field.



9. Tap the **Save** soft key to accept the change or  to cancel.
10. Tap the **DSS Key** key to return to the idle screen.

Intercom key is configurable via web user interface at the path **DSSKey->Line Key**.

**To place an intercom call:**

1. Tap the intercom key when the phone is idle.  
The phone is automatically connected to the extension specified in the **Value** field.
2. Tap the intercom key again or the **End Call** soft key to end the intercom call.

## Incoming Intercom Calls

The SIP-T48G IP phone supports to automatically answer an incoming intercom call by default. The phone automatically plays a warning tone when it receives an incoming intercom call. In addition, you can enable the phone to mute the microphone when it automatically answers an incoming intercom call. You can also enable the phone to automatically answer an incoming intercom call while there is already an active call on the phone. The active call is placed on hold.

Intercom features you need to know:

Intercom Feature	Description
Accept Intercom	Enable or disable the IP phone to automatically answer an incoming intercom call.
Intercom Mute	Enable or disable the microphone on the IP phone for intercom calls.
Intercom Tone	Enable or disable the IP phone to play a warning tone when it receives an incoming intercom call.
Intercom Barge	Enable or disable the IP phone to automatically answer an incoming intercom call while there is already an active call on the phone.

To configure intercom features via phone user interface:

1. Tap  -> **Call Features**->**Intercom**.
2. Make the desired changes.



3. Tap the **Save** soft key to accept the change or  to cancel.

These specific parameters are configurable via web user interface at the path **Features->Intercom**.

### Accept Intercom

You can enable or disable the phone to automatically answer an incoming intercom call. If Accept Intercom is enabled, the phone automatically answers an incoming intercom call. If Accept Intercom is disabled, the phone rejects incoming intercom calls and sends a busy message to the caller. Accept Intercom is enabled by default.

#### Note

Your administrator can set a period of delay time before the phone automatically answers intercom calls. Contact your system administrator for more information.

### Intercom Mute

You can mute or un-mute the microphone on the phone for intercom calls automatically. If Intercom Mute is enabled, the microphone is muted for intercom calls. If Intercom Mute is disabled, the microphone works for intercom calls. Intercom Mute is disabled by default.

### Intercom Tone

You can enable or disable the phone to play a warning tone when receiving an intercom call. If Intercom Tone is enabled, the phone plays a warning tone before answering the intercom call. If Intercom Tone is disabled, the phone automatically answers the intercom call without warning. Intercom Tone is enabled by default.

### Intercom Barge

You can enable or disable the phone to automatically answer an incoming intercom call while there is already an active call on the phone. If Intercom Barge is enabled, the phone automatically answers the intercom call and places the active call on hold. If Intercom Barge is disabled, the phone handles an incoming intercom call like a waiting call. Intercom Barge is disabled by default.

## Multicast Paging

You can use multicast paging to quickly and easily forward time sensitive announcements out to people within the multicast group. You can configure a multicast paging key on the phone, which allows you to send a Real Time Transport Protocol (RTP) stream to the pre-configured multicast address(es) without involving SIP signaling. You can configure the phone to receive an RTP stream from pre-configured multicast listening address(es) without involving SIP signaling. You can specify up to 10 multicast listening addresses.

## Sending RTP Stream

**To configure a multicast paging key via phone user interface:**

1. Tap the **DSS Key** key.
2. Tap the desired line key.
3. Tap the gray box of the **Type** field.
4. Tap **Key Event** from the pull-down list.
5. Tap the gray box of the **Key Event** field.
6. Tap **Multicast Paging** from the pull-down list.
7. (Optional.) Enter the string that will appear on the touch screen in the **Label** field.
8. Enter the multicast IP address and port number (e.g., 224.5.6.20:10008) in the **Value** field.

The valid multicast IP addresses range from 224.0.0.0 to 239.255.255.255.



9. Tap the **Save** soft key to accept the change or  to cancel.
10. Tap the **DSS Key** key to return to the idle screen.

Multicast paging key is configurable via web user interface at the path **DSSKey->Line Key**.

You can also configure the phone to use a default codec for sending multicast RTP stream via web user interface.

**To configure a default codec for multicast paging via web user interface:**

1. Click on **Features->General Information**.
2. Select the desired codec from the pull-down list of **Multicast Codec**.

The default codec is G722.

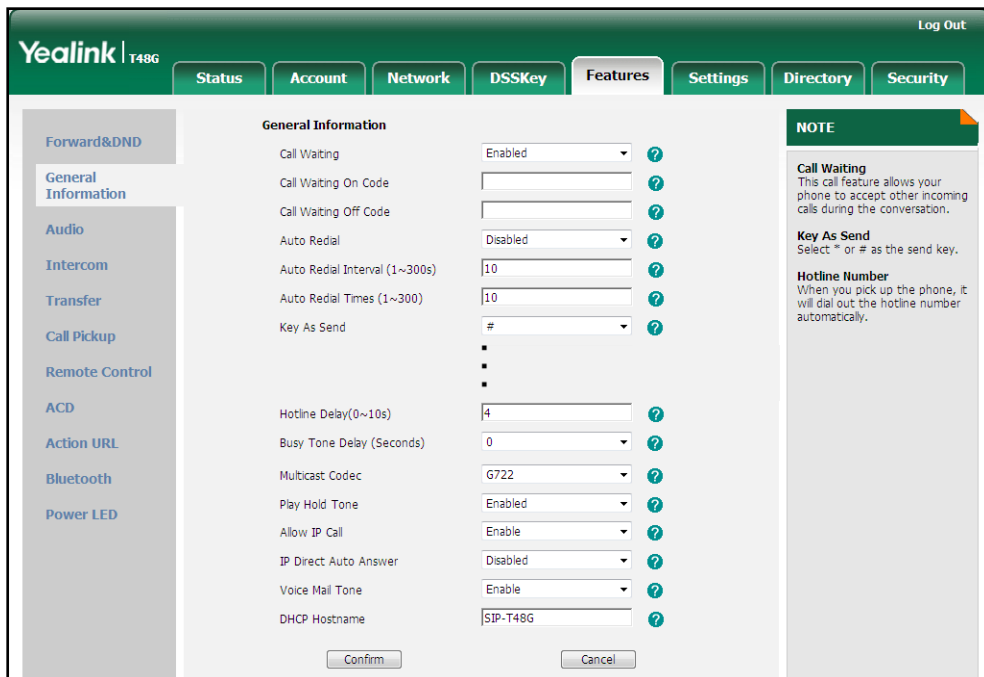

3. Click **Confirm** to accept the change.

**Note**

If G722 codec is used for multicast paging, the touch screen displays the icon  to indicate that is providing high definition voice.

Default codec for multicast paging is configurable via web user interface only.

**To send RTP stream:**

1. Tap the multicast paging key when the phone is idle.

The phone sends RTP to a preconfigured multicast address (IP: Port). Any phone configured to listen to the multicast address may automatically answer the paging call and play receiving RTP. For more information on how to configured a phone to listen to a multicast, refer to [Receiving RTP Stream](#) on page 137. For both sending and receiving of the multicast RTP, there is no SIP signaling involved.

The multicast paging key illuminates solid green.

The following figure shows a multicast RTP session on the phone:



2. Tap the **Hold** soft key to place the current multicast RTP session on hold.
3. Tap the **End Call** soft key to cancel the multicast RTP session.

**Note**

Multicast RTP is one way only from sender to the multicast address(es) (receiver). For outgoing RTP multicasts, all other existing calls on the phone will be placed on hold.

## Receiving RTP Stream

You can configure the phone to receive a Real Time Transport Protocol (RTP) stream from the pre-configured multicast address(es) without involving SIP signaling. You can specify up to 10 multicast addresses that the phone listens to on the network.

How the phone handles incoming multicast paging calls depends on Paging Barge and Paging Priority Active parameters configured via web user interface.

### Paging Barge

Paging barge parameter defines the priority of the voice call in progress. If the priority of an incoming multicast paging call is lower than that of the active call, it will be ignored automatically. If Disabled is selected from the pull-down list of Paging Barge, the voice call in progress takes precedence over all incoming multicast paging calls. Valid values in the Paging Barge field:

- **1 to 10:** Define the priority of the active call, 1 with the highest priority, 10 with the lowest.
- **Disabled:** The voice call in progress shall take precedence over all incoming paging calls.

### Paging Priority Active

Paging priority active parameter decides how the phone handles incoming multicast paging calls when there is already a multicast paging call on the phone. If enabled, the phone will ignore incoming multicast paging calls with lower priorities, otherwise, the phone will answer incoming multicast paging calls automatically and place the previous multicast paging call on hold. If disabled, the phone will automatically ignore all incoming multicast paging calls.

To configure multicast listening addresses via web user interface:

1. Click on **Directory->Multicast IP**.
2. Select the desired value from the pull-down list of **Paging Barge**.
3. Select the desired value from the pull-down list of **Paging Priority Active**.
4. Enter the multicast IP address(es) and port number (e.g., 224.5.6.20:10008) which the phone listens for incoming RTP multicast in the **Listening Address** field.
5. Enter the label in the **Label** field.

Label will appear on the touch screen when receiving the multicast RTP stream.

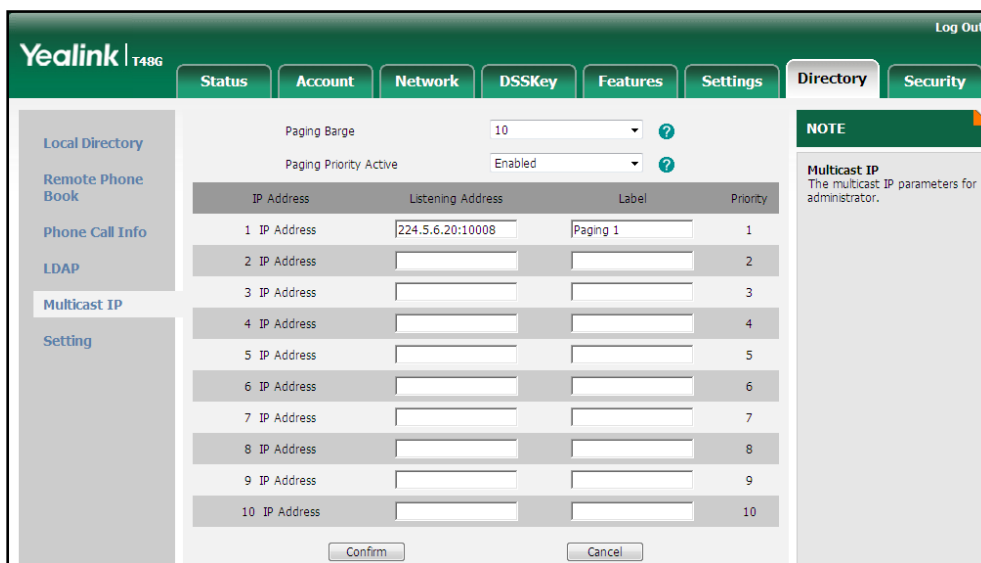



- Click **Confirm** to accept the change.

**Note**

The priorities of listening addresses are predefined: 1 with the highest priority, 10 with the lowest.

Both the multicast paging sender and the receiver play a warning tone when establishing a multicast paging call.

Multicast listening addresses are configurable via web user interface only.

## Music on Hold

Music on hold (MoH) is the business practice of playing recorded music to fill the silence that would be heard by the party placed on hold. To use this feature, you should specify a SIP URI pointing to a Music on Hold Server account. When a call is placed on hold, the phone will send a SIP INVITE message to the Music on Hold Server account. The Music on Hold Server account automatically answers to the SIP INVITE messages and immediately plays audio from some source located anywhere (LAN, Internet) to the held party. Contact your system administrator for the SIP URI.

**To configure music on hold server via web user interface:**

- Click on **Account**.
- Select the desired account from the pull-down list of **Account**.
- Click on **Advanced**.
- Enter the SIP URI (e.g., sip:moh@sip.com) in the **Music Server URI** field.

The screenshot shows the Yealink T48G web user interface. The top navigation bar includes 'Status', 'Account', 'Network', 'DSSKey', 'Features', 'Settings', 'Directory', and 'Security'. The 'Account' tab is active, and the 'Advanced' sub-tab is selected. The 'Account' dropdown menu is set to 'Account 1'. The 'Music Server URI' field contains the value 'sip:moh@sip.com'. Other fields include 'Keep Alive Type' (Default), 'Keep Alive Interval(Seconds)' (30), 'Local SIP Port' (5062), 'RPort' (Disabled), 'SIP Session Timer T1 (0.5~10s)' (0.5), 'SIP Session Timer T2 (2~40s)' (4), 'SIP Session Timer T4 (2.5~60s)' (5), 'Subscribe Period(Seconds)' (1800), 'SIP Server Type' (Default), 'Directed Call Pickup Code', 'Group Call Pickup Code', 'Distinctive Ring Tones' (Disabled), 'Unregister When Reboot' (Disabled), and 'Out Dialog BLF' (Disabled). A 'NOTE' box on the right states: 'Advanced: The Advanced parameters for administrator.' At the bottom, there are 'Confirm' and 'Cancel' buttons.

- Click **Confirm** to accept the change.

When you place a call on hold, the held party can hear the music.

**Note** All involved parties cannot use encrypted RTP (SRTP).  
Music on hold server is configurable via web user interface only.

## Messages

### Voice Mail

You can leave voice mails for someone else on the SIP-T48G IP phone. You can also listen to the voice mails stored in a centralized location. When receiving a new voice mail, the phone will play a warning tone, and the power indicator LED will slow flash red. The touch screen will prompt receiving a new voice mail with the number of waiting voice mails (e.g., New Voice Mail(1)) and the  icon.

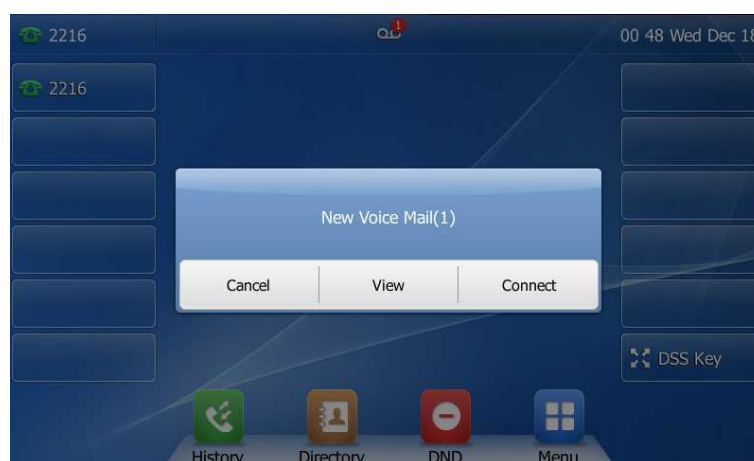

**Note** Voice Mail is not available on all servers. Contact your system administrator for more information.  
The  icon on the status bar has a counter indicating the number of messages you haven't heard yet.

#### To leave a voice mail:

You can leave a voice mail for someone else when he/she is busy or inconvenient to answer the call. Follow the voice prompt from the system server to leave a voice mail, and then hang up.

#### To configure voice mail access codes via phone user interface:

1. Tap  ->Messages->Set Voice Mail.
2. Enter the voice mail access code (e.g., \*88) in the desired account field.

You can tap the **123** soft key to select the proper input mode.

Account	Code
1.Account1 Code	*88
2.Account2 Code	
3.Account3 Code	
4.Account4 Code	
5.Account5 Code	
6.Account6 Code	

3. Tap the **Save** soft key to accept the change or to cancel.

**Note** Voice mail access code must be predefined on the system server. Contact your system administrator for the more information.

#### To listen to voice mails:

1. When the phone prompts receiving a new voice mail, press or tap the **Connect** soft key to dial out the voice mail access code.
2. Follow the voice prompt to listen to voice mails.  
You can tap the icon when the phone is idle to pop up the dialog box, and then tap the **Connect** soft key.

**Note** Before listening to voice mails, make sure the voice mail access code has been configured.

When all new voice mails are retrieved, the power indicator LED will go out.

**To view the voice mail via phone user interface:**

1. Tap  -> **Messages**->**View Voice Mail**.

The touch screen displays the amount of new and old voice mails

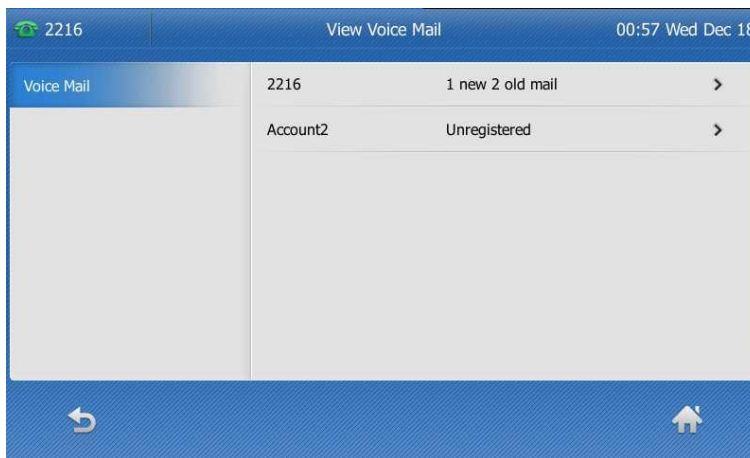

You can tap the account to listen to voice mails.

## Message Waiting Indicator (MWI)

The SIP-T48G IP phone supports MWI when receiving a new voice message. If someone leaves you a voice mail, you will receive a message waiting indicator. MWI will be indicated in three ways: a warning tone, an indicator message (including a voice mail icon) on the touch screen, and the power indicator LED slow flashes red. This will be cleared when you retrieve all voice mails or delete them.

The MWI service is unsolicited for some servers, so the SIP-T48G IP phone only handles the MWI messages sent from the server. But for other servers, the MWI service is solicited, so the SIP-T48G IP phone must enable subscription for MWI.

**Note**

MWI service is not available on all servers. Contact your system administrator for more information.

The MWI subscription parameters you need to know:

Options	Description
<b>Subscribe for MWI</b>	Enable or disable a subscription for MWI service.
<b>MWI Subscription Period</b>	Period of MWI subscription. The IP phone sends a refresh SUBSCRIBE request before initial subscription expires.
<b>Subscribe MWI To Voice Mail</b>	Enable or disable a subscription to the voice mail number for MWI service. To use this feature, you should also configure the

voice mail number.
--------------------

**Note**

Whether the phone sends SUBSCRIBE messages for MWI service to the account or the voice number MWI service depends on the server. Contact your system administrator for more information.

**To configure subscribe for MWI via web user interface**

1. Click on **Account**.
2. Select the desired account from the pull-down list of **Account**.
3. Click on **Advanced**.
4. Select **Enabled** from the pull-down list of **Subscribe for MWI**.
5. Enter the period time in the **MWI Subscription Period (Seconds)** field.

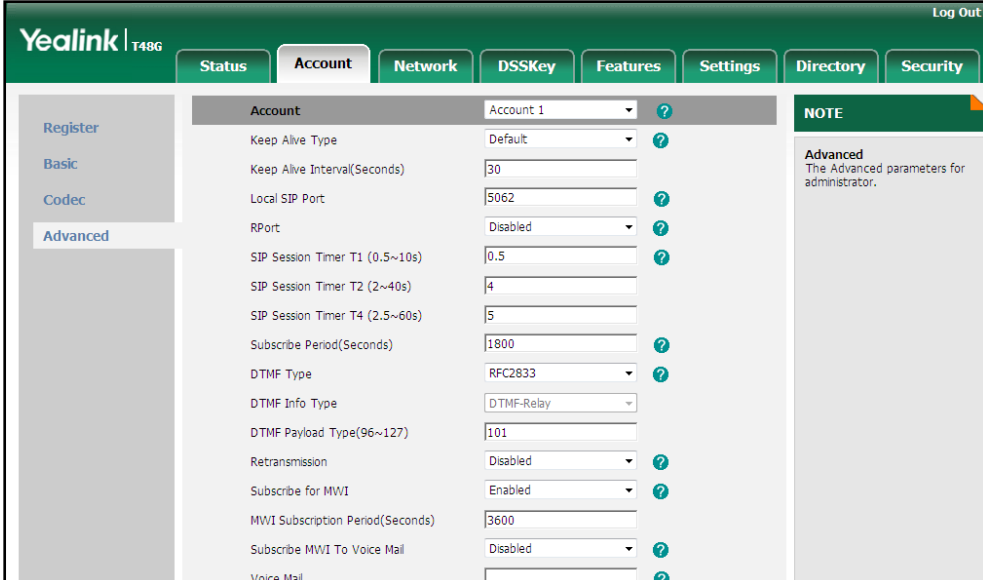

Account	Account 1	?
Keep Alive Type	Default	?
Keep Alive Interval(Seconds)	30	
Local SIP Port	5062	?
RPort	Disabled	?
SIP Session Timer T1 (0.5~10s)	0.5	?
SIP Session Timer T2 (2~40s)	4	
SIP Session Timer T4 (2.5~60s)	5	
Subscribe Period(Seconds)	1800	?
DTMF Type	RFC2833	?
DTMF Info Type	DTMF-Relay	
DTMF Payload Type(96~127)	101	
Retransmission	Disabled	?
Subscribe for MWI	Enabled	?
MWI Subscription Period(Seconds)	3600	
Subscribe MWI To Voice Mail	Disabled	?
Voice Mail		?

**NOTE**  
Advanced  
The Advanced parameters for administrator.

6. Click **Confirm** to accept the change.

The IP phone will subscribe to the account number for MWI service by default.

**To enable Subscribe MWI to Voice Mail via web user interface:**

1. Click on **Account**.
2. Select the desired account from the pull-down list of **Account**.
3. Click on **Advanced**.
4. Select **Enabled** from the pull-down list of **Subscribe MWI To Voice Mail**.

- Enter the desired voice mail number in the **Voice Mail** field.

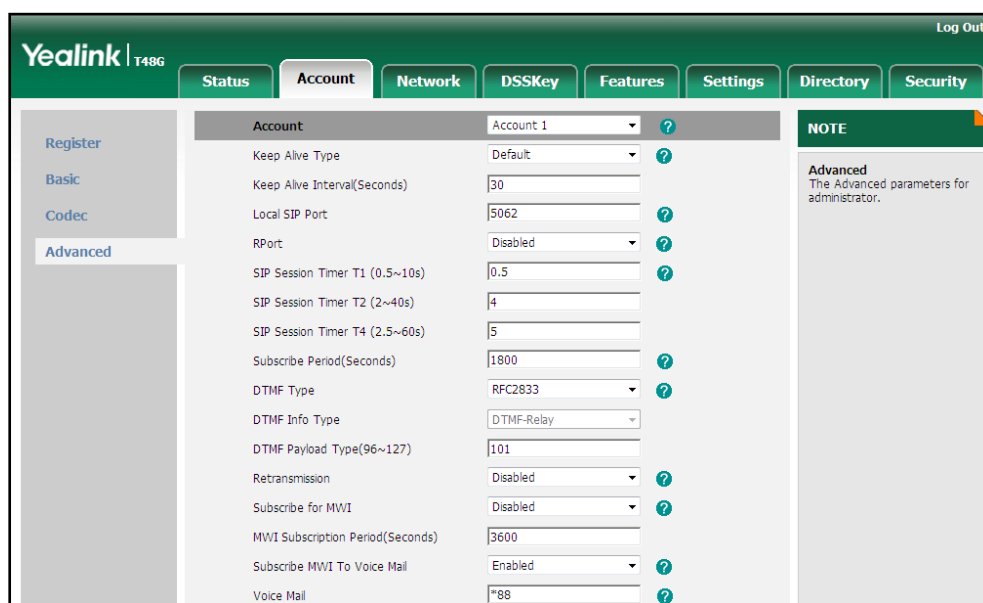

- Click **Confirm** to accept the change.

The IP phone will subscribe to the voice mail number for MWI service using **Subscribe MWI to Voice Mail**.

**Note** MWI subscription is configurable via web user interface only.

# Troubleshooting

---

This chapter provides general troubleshooting information to help you solve the problems you might encounter when using your SIP-T48G IP phone.

If you require additional information or assistance with your new phone, contact your system administrator.

## Why is the touch screen blank?

- Ensure that the phone is properly plugged into a functional AC outlet.
- Ensure the output of the power adapter is 5V/2A.
- Ensure that the phone is plugged into a socket controlled by a switch that is on.
- If the phone is plugged into a power strip, try to plug it directly into a wall outlet instead.
- If the phone is powered from PoE, ensure you use a PoE-compliant switch or hub.

## Why does the phone display "Network Unavailable"?

- Ensure that the Ethernet cable is plugged into the Internet port on the phone and the Ethernet cable is not loose.
- Ensure that the switch or hub in your network is operational.

## Why doesn't the phone display time and date correctly?

Check if you have configured the phone to obtain the time and date from the SNTP server automatically. If the phone fails to connect the SNTP server, contact your system administrator for more information. You can also configure the time and date manually. For more information, refer to [Time & Date](#) on page 27.

## How do I find the basic information of the IP phone?

Press the OK key when the IP phone is idle to check the basic information of the IP phone, such as IP address and firmware version. For more basic information, refer to [Phone Status](#) on page 18.

## How to obtain the MAC address of a phone when the phone is not powered on?

Three ways to obtain the MAC address of a phone:

- You can ask your supplier for shipping information sheet which includes MAC addresses according to the corresponding PO (Purchase Order).
- You can find the MAC address in the label of carton box.

- You can also find the MAC address from the phone's bar code on the back of the phone.

#### **Why can't I get a dial tone?**

- Check for any loose connections and that the phone has been installed properly. For the installation instructions, refer to [Phone Installation](#) on page 11.
- Switch between the Handset, Headset (if present) or Hands-Free Speakerphone to check whether the dial tone is present for one of the audio modes.  
If the dial tone exists on another audio mode, connect a different handset or headset to isolate the problem.

#### **Why doesn't the phone ring?**

Check the ringer volume on the phone. To adjust the ringer volume setting, press the Volume key when the phone is on-hook and idle. For more information, refer to [Volume](#) on page 31.

#### **Why can't I receive calls?**

- Check the SIP registration with your system administrator.
- Check that DND (Do Not Disturb) mode is deactivated on your phone. Refer to [Do Not Disturb \(DND\)](#) on page 99.
- Check that call forward is disabled on the phone. Refer to [Call Forward](#) on page 104.
- Check whether the caller number is stored in the blacklist directory. Refer to [Blacklist](#) on page 51.

#### **Why does my handset not work?**

Check that the handset cord is fully connected to both the handset jack on the phone and handset. Refer to [Phone Installation](#) on page 11.

#### **Why does my headset not work?**

- Check that the headset cord is fully connected to the headset jack on the phone. Refer to [Phone Installation](#) on page 11.
- Check that the headset mode is activated. Refer to [Headset Use](#) on page 59.
- Check that the headset volume is adjusted to an appropriate level. Refer to [Volume](#) on page 31.

#### **What is the difference between user name, register name and display name?**

Both user name and register name are defined by the server. A user name is used to identify the account while a register name matched with a password is used for



authentication if the server requires. Display name is the caller ID that will be displayed on the callee’s touch screen. Server configuration may override the local configuration.

### Why does the phone play a tone when there is a call on hold? How to disable it?

When there is a call on hold, the phone will play a hold tone every 30 seconds. Call hold tone is enabled by default. Call hold tone and the interval of playing a hold tone are configurable via web user interface only.

To configure call hold tone and call hold tone delay via web user interface:

1. Click on **Features->General Information**.
2. Select the desired value from the pull-down list of **Play Hold Tone**.
3. Enter the desired time in the **Play Hold Tone Delay** field.

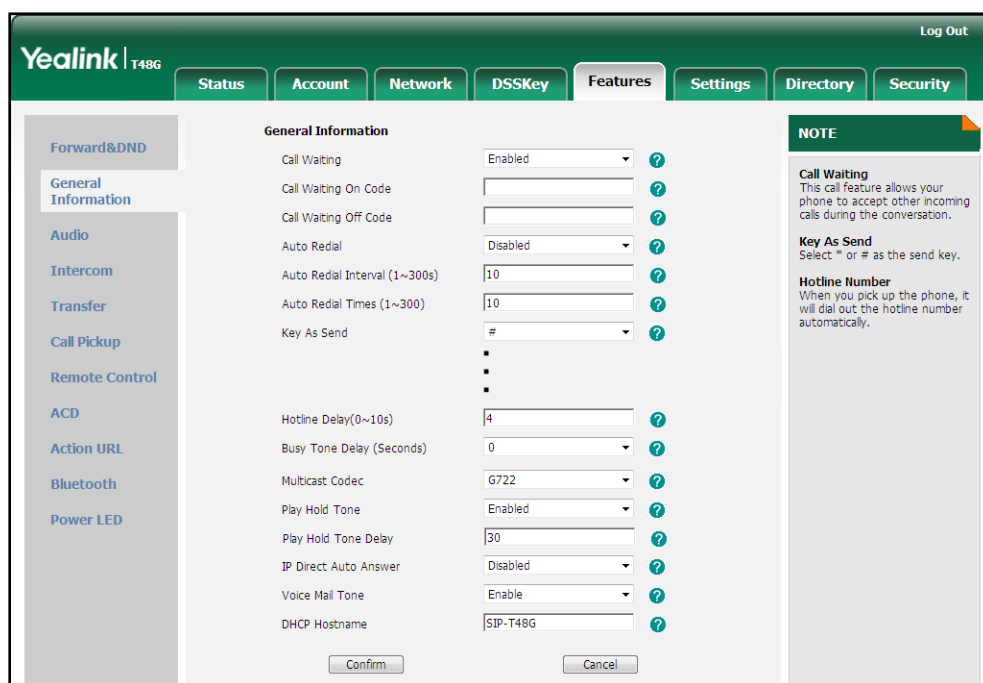

4. Click **Confirm** to accept the change.

### Why does the wallpaper has bad display?

Do one of the following:

- Check that the custom image is clear.
- Check that the file format of the custom image for the wallpaper is \*.jpg, \*.png or \*.bmp.
- Check that the custom image is not too large or small. The phone will adjust the image with the short side to display.
- Check that the picture resolution of the wallpaper. The wallpaper resolution of the SIP-T48G IP phone is 800\*480 pixels.

### How to change the user password?

To change the user password via web user interface:

1. Click on **Security**->**Password**.
2. Select **user** from the pull-down list of **User Type**.
3. Enter the new user password in the **New Password** field and **Confirm Password** field.

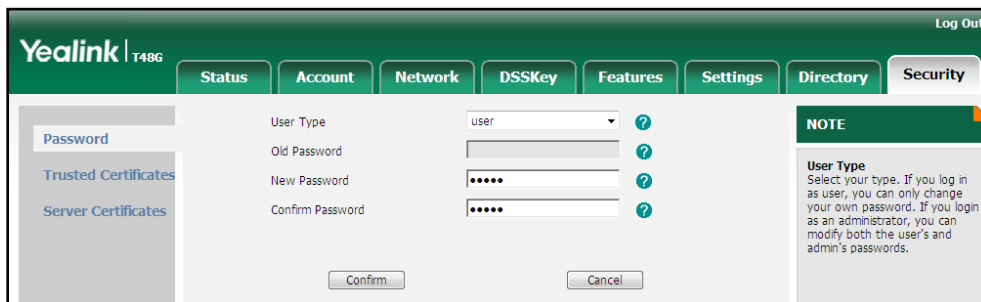

4. Click **Confirm** to accept the change.

You can also contact your system administrator for help.

**Note**

If logging into the web user interface of the phone with the user credential, you need to enter the current user password in the **Old Password** field.

User password is configurable via web user interface only.

### How to make a call using SRTP?

You can enable SRTP to encrypt the audio stream(s) of phone calls. The parties participating in the call should enable SRTP on a per-line basis.

To enable SRTP on a per-line basis via web user interface:

1. Click on **Account**.
2. Select the desired account from the pull-down list of **Account**.
3. Click on **Advanced**.

- Select the desired value (Optional or Compulsory) from the pull-down list of RTP Encryption (SRTP).

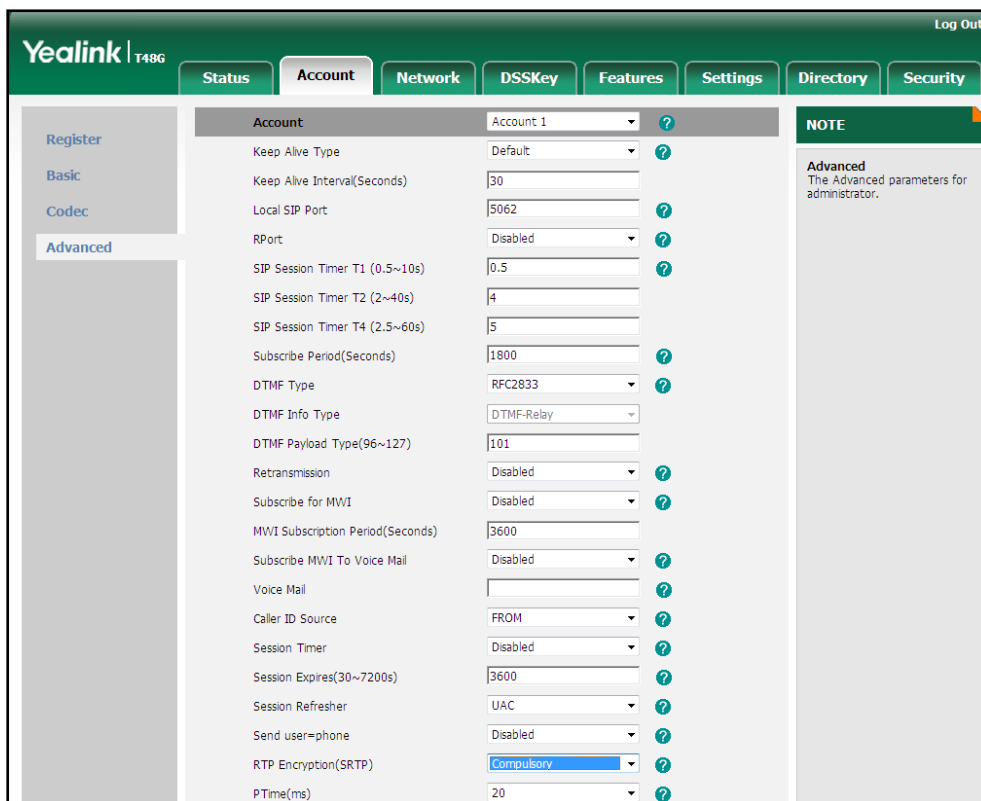

- Click **Confirm** to accept the change.

**Note** SRTP is not available on all servers. Contact your system administrator for more information.  
SRTP is configurable via web user interface only.

### How to reboot the phone?

To reboot the phone via web user interface:

- Click on **Settings->Upgrade**.
- Click **Reboot** to reboot the IP phone.

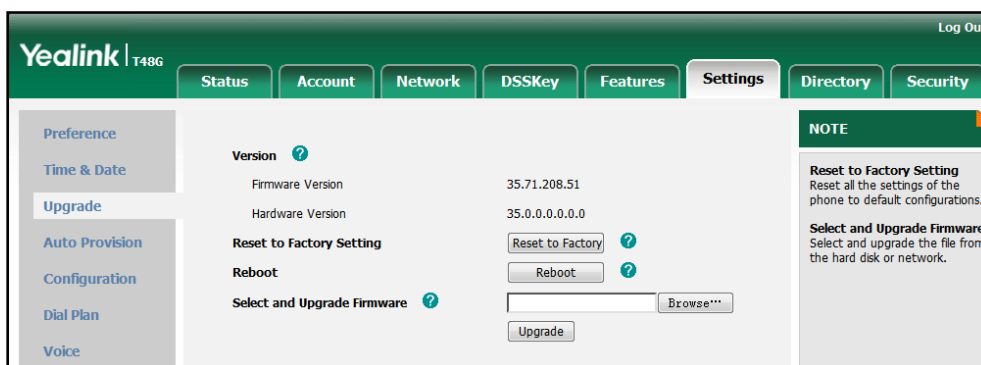

Any reboot of the phone may take a few minutes.

### How to export PCAP trace?

We may need you to provide a PCAP trace to help analyze your problem.

#### To export a PCAP trace via web user interface:

1. Click on **Settings->Configuration**.
2. Click **Start** to begin capturing signal traffic.
3. Recreate the error to be documented in the trace.
4. Click **Stop** to stop the capture.
5. Click **Export** to open file download window, and then save the file to your local system.

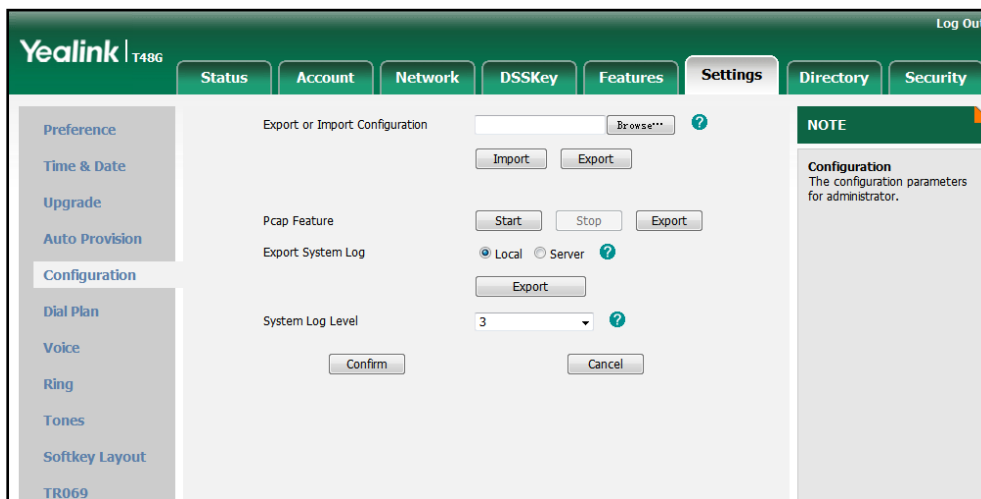

### How to export system log?

We may need you to provide a system log to help analyze your problem.

#### To export the system log to local PC via web user interface:

1. Click on **Settings->Configuration**.
2. Select **6** from the pull-down list of **System Log Level**.
3. Click **Confirm** to accept the change.

The web user interface prompts “Do you want to restart your machine?”. The configuration will take effect after reboot.

4. Click **OK** to reboot the phone.  
After the IP phone finishes reboot, the system log level is set as 6, the debug level.
5. Mark the **Local** radio box in the **Export System Log** field.
6. Reproduce the issue.

- Click **Export** to open file download window, and then save the file to your local system.

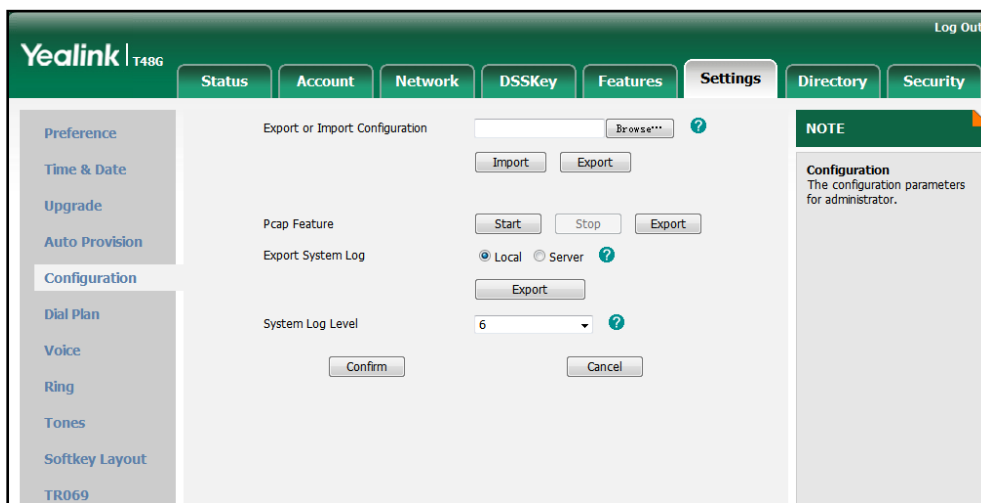

You can also export the system log to a syslog server, contact your system administrator for more information.

**Note**

It is recommended to reset the syslog level to 3 after exporting the system syslog.

**How to export/import the phone configurations?**

We may need you to provide the phone configurations to help analyze problem. In some instance, you may need to import configurations to your phone.

**To export the phone configurations via web user interface:**

- Click on **Settings->Configuration**.
- Click **Export** to open file download window, and then save the file to your local system.

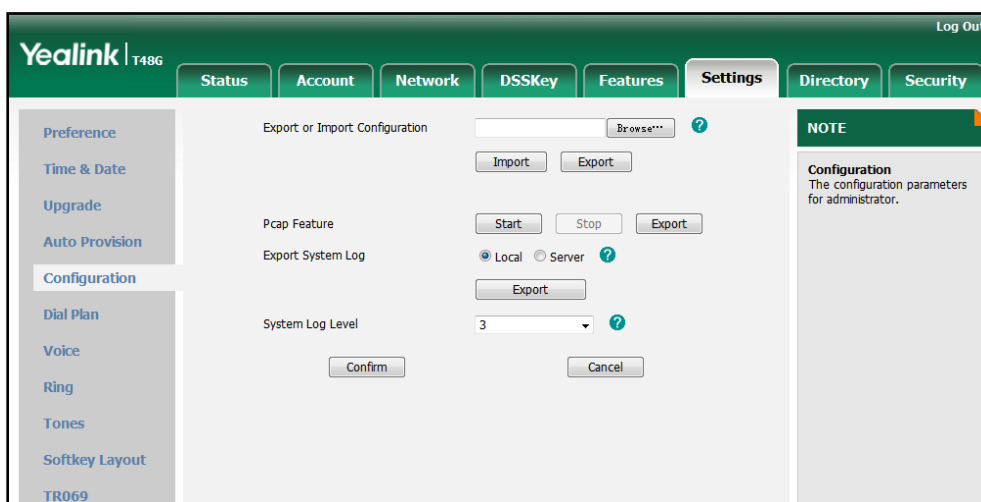

**To import the phone configurations via web user interface:**

1. Click on **Settings->Configuration**.
2. Click **Browse** to locate a configuration file from your local system.
3. Click **Import** to import the configuration file.

**Note**

The file format of configuration file must be \*.bin.

**How to upgrade firmware?**

**To upgrade firmware via web user interface:**

1. Click on **Settings->Upgrade**.
2. Click **Browse** to locate the firmware from your local system.

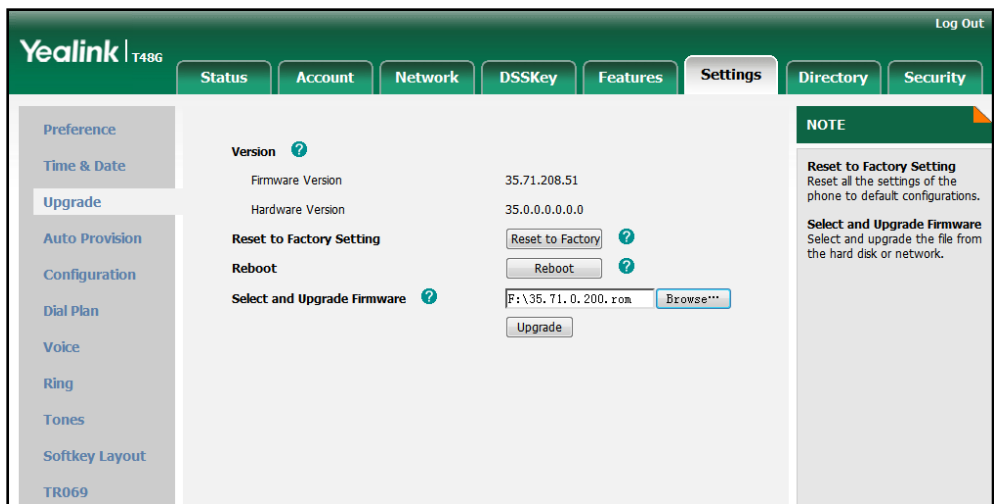

3. Click **Upgrade** to upgrade the firmware.  
 The browser pops up the dialog box "Firmware of the SIP Phone will be updated. It will take 5 minutes to complete. Please don't power off!".
4. Click **OK** to confirm upgrading.

**How to reset the phone?**

Reset the phone to factory configurations after you have tried almost all troubleshooting suggestions but do not solve the problem. You need to note that all custom settings will be overwritten after reset.

**To reset the phone via phone user interface:**

1. Tap  ->**Advanced** (password: admin) ->**Reset to Factory**.
2. Tap the gray box of the **Reset Option** field.
3. Tap the desired reset option from the pull-down list.

4. Tap the **Reset** key.

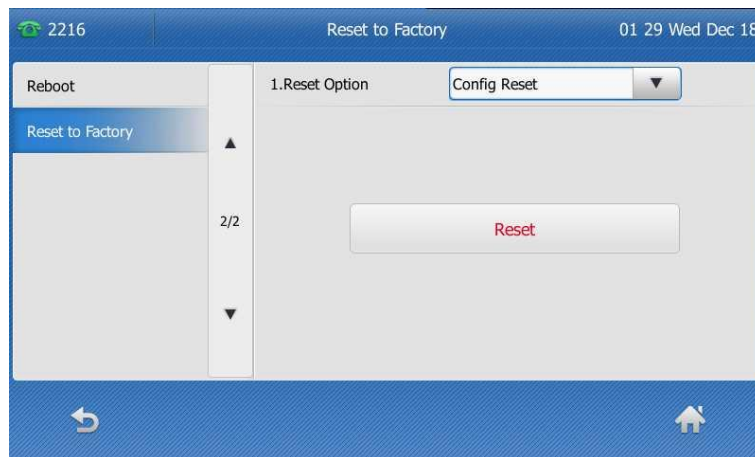

The touch screen prompts the following warning:

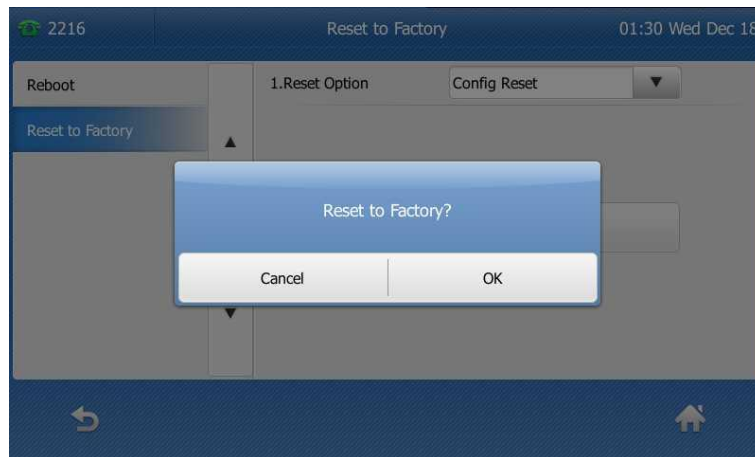

5. Tap the **OK** soft key.

The phone begins resetting.

After reset, the touch screen prompts "Welcom Initializing...Please wait".

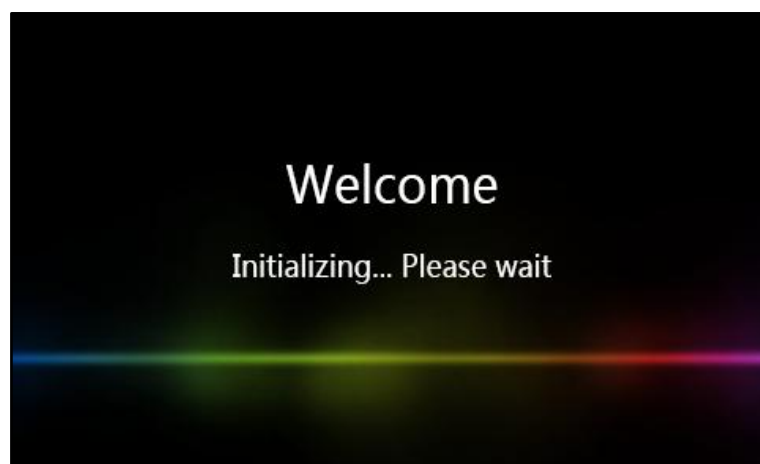

The phone will be reset to factory successfully after startup.

**Note**

Reset of the phone may take a few minutes. Do not power off until the phone starts up successfully.



## Regulatory Notices

### Service Agreements

Contact your Yealink Authorized Reseller for information about service agreements applicable to your product.

### Limitations of Liability

TO THE FULL EXTENT ALLOWED BY LAW, YEALINK EXCLUDES FOR ITSELF AND ITS SUPPLIERS ANY LIABILITY, WHETHER BASED IN CONTRACT OR TORT (INCLUDING NEGLIGENCE), FOR INCIDENTAL, CONSEQUENTIAL, INDIRECT, SPECIAL, OR PUNITIVE DAMAGES OF ANY KIND, OR FOR LOSS OF REVENUE OR PROFITS, LOSS OF BUSINESS, LOSS OF INFORMATION OR DATA, OR OTHER FINANCIAL LOSS ARISING OUT OF OR IN CONNECTION WITH THE SALE, INSTALLATION, MAINTENANCE, USE, PERFORMANCE, FAILURE, OR INTERRUPTION OF ITS PRODUCTS, EVEN IF YEALINK OR ITS AUTHORIZED RESELLER HAS BEEN ADVISED OF THE POSSIBILITY OF SUCH DAMAGES, AND LIMITS ITS LIABILITY TO REPAIR, REPLACEMENT, OR REFUND OF THE PURCHASE PRICE PAID, AT YEALINK'S OPTION. THIS DISCLAIMER OF LIABILITY FOR DAMAGES WILL NOT BE AFFECTED IF ANY REMEDY PROVIDED HEREIN SHALL FAIL OF ITS ESSENTIAL PURPOSE.

### Safety Instructions

**Save these instructions. Read these safety instructions before use!**

The following basic safety precautions should always be followed to reduce risk of fire, electrical shock, and other personal injury.

#### General Requirements

- Before you install and use the device, read the safety instructions carefully and observe the situation during operation.
- During the process of storage, transportation, and operation, please always keep the device dry and clean.
- During the process of storage, transportation, and operation, please avoid collision and crash of the device.
- Please attempt not to dismantle the device by yourself. In case of any discrepancy, please contact the appointed maintenance center for repair.
- Without prior written consent, no organization or individual is permitted to make any change to the structure or the safety design of the device. Yealink is under no circumstance liable to consequences or legal issues caused by such changes.
- Please refer to the relevant laws and statutes while using the device. Legal rights of others should be respected as well.

#### Environmental Requirements

- Place the device at a well-ventilated place. Do not expose the device under direct sunlight.

- Keep the device dry and free of dusts.
- Place the device on a stable and level platform.
- Please place no heavy objects on the device in case of damage and deformation caused by the heavy load.
- Keep at least 10 cm between the device and the closest object for heat dissipation.
- Do not place the device on or near any inflammable or fire-vulnerable object, such as rubber-made materials.
- Keep the device away from any heat source or bare fire, such as a candle or an electric heater.
- Keep the device away from any household appliance with strong magnetic field or electromagnetic field, such as a microwave oven or a refrigerator.

### **Operating Requirements**

- Do not let a child operate the device without guidance.
- Do not let a child play with the device or any accessory in case of accidental swallowing.
- Please use the accessories provided or authorized by the manufacturer only.
- The power supply of the device shall meet the requirements of the input voltage of the device. Please use the provided surge protection power socket only.
- Before plugging or unplugging any cable, make sure that your hands are completely dry.
- Do not spill liquid of any kind on the product or use the equipment near water, for example, near a bathtub, washbowl, kitchen sink, wet basement or near a swimming pool.
- Do not tread on, pull, or over-bend any cable in case of malfunction of the device.
- During a thunderstorm, stop using the device and disconnect it from the power supply. Unplug the power plug and the Asymmetric Digital Subscriber Line (ADSL) twisted pair (the radio frequency cable) to avoid lightning strike.
- If the device is left unused for a rather long time, disconnect it from the power supply and unplug the power plug.
- When there is smoke emitted from the device, or some abnormal noise or smell, disconnect the device from the power supply, and unplug the power plug immediately. Contact the specified maintenance center for repair.
- Do not insert any object into equipment slots that is not part of the product or auxiliary product.
- Before connecting a cable, connect the grounding cable of the device first. Do not disconnect the grounding cable until you disconnect all other cables.

### **Cleaning Requirements**

- Before cleaning the device, stop using it and disconnect it from the power supply.
- Use a piece of soft, dry and anti-static cloth to clean the device.
- Keep the power plug clean and dry. Using a dirty or wet power plug may lead to electric shock or other perils.

## Appendix A - Time Zones

Time Zone	Time Zone Name
- 11:00	Samoa
- 10:00	United States-Hawaii-Aleutian
- 10:00	United States-Alaska-Aleutian
- 09:00	United States-Alaska Time
- 08:00	Canada(Vancouver, Whitehorse)
- 08:00	Mexico(Tijuana, Mexicali)
- 08:00	United States-Pacific Time
- 07:00	Canada(Edmonton, Calgary)
- 07:00	Mexico(Mazatlan, Chihuahua)
- 07:00	United States-Mountain Time
- 07:00	United States-MST no DST
- 06:00	Canada-Manitoba(Winnipeg)
- 06:00	Chile(Easter Islands)
- 06:00	Mexico(Mexico City, Acapulco)
- 06:00	United States-Central Time
- 05:00	Bahamas(Nassau)
- 05:00	Canada(Montreal, Ottawa, Quebec)
- 05:00	Cuba(Havana)
- 05:00	United States-Eastern Time
- 04:30	Venezuela(Caracas)
- 04:00	Canada(Halifax, Saint John)
- 04:00	Chile(Santiago)
- 04:00	Paraguay(Asuncion)
- 04:00	United Kingdom-Bermuda(Bermuda)
- 04:00	United Kingdom(Falkland Islands)
- 04:00	Trinidad&Tobago
- 03:30	Canada-New Foundland(St.Johns)
- 03:00	Denmark-Greenland(Nuuk)
- 03:00	Argentina(Buenos Aires)
- 03:00	Brazil(no DST)
- 03:00	Brazil(DST)
- 02:00	Brazil(no DST)
- 01:00	Portugal(Azores)
0	GMT
0	Greenland
0	Denmark-Faroe Islands(Torshavn)
0	Ireland(Dublin)
0	Portugal(Lisboa, Porto, Funchal)
0	Spain-Canary Islands(Las Palmas)
0	United Kingdom(London)
0	Morocco
+ 01:00	Albania(Tirane)
+ 01:00	Austria(Vienna)
+ 01:00	Belgium(Brussels)
+ 01:00	Caicos
+ 01:00	Chad
+ 01:00	Spain(Madrid)
+ 01:00	Croatia(Zagreb)
+ 01:00	Czech Republic(Prague)
+ 01:00	Denmark(Kopenhagen)
+ 01:00	France(Paris)

Time Zone	Time Zone Name
+01:00	Germany(Berlin)
+01:00	Hungary(Budapest)
+01:00	Italy(Rome)
+01:00	Luxembourg(Luxembourg)
+01:00	Macedonia(Skopje)
+01:00	Netherlands(Amsterdam)
+01:00	Namibia(Windhoek)
+02:00	Estonia(Tallinn)
+02:00	Finland(Helsinki)
+02:00	Gaza Strip(Gaza)
+02:00	Greece(Athens)
+02:00	Israel(Tel Aviv)
+02:00	Jordan(Amman)
+02:00	Latvia(Riga)
+02:00	Lebanon(Beirut)
+02:00	Moldova(Kishinev)
+02:00	Russia(Kaliningrad)
+02:00	Romania(Bucharest)
+02:00	Syria(Damascus)
+02:00	Turkey(Ankara)
+02:00	Ukraine(Kyiv, Odessa)
+03:00	East Africa Time
+03:00	Iraq(Baghdad)
+03:00	Russia(Moscow)
+03:30	Iran(Teheran)
+04:00	Armenia(Yerevan)
+04:00	Azerbaijan(Baku)
+04:00	Georgia(Tbilisi)
+04:00	Kazakhstan(Aktau)
+04:00	Russia(Samara)
+04:30	Afghanistan
+05:00	Kazakhstan(Aqtobe)
+05:00	Kyrgyzstan(Bishkek)
+05:00	Pakistan(Islamabad)
+05:00	Russia(Chelyabinsk)
+05:30	India(Calcutta)
+06:00	Kazakhstan(Astana, Almaty)
+06:00	Russia(Novosibirsk, Omsk)
+07:00	Russia(Krasnoyarsk)
+07:00	Thailand(Bangkok)
+08:00	China(Beijing)
+08:00	Singapore(Singapore)
+08:00	Australia(Perth)
+09:00	Korea(Seoul)
+09:00	Japan(Tokyo)
+09:30	Australia(Adelaide)
+09:30	Australia(Darwin)
+10:00	Australia(Sydney, Melbourne, Canberra)
+10:00	Australia(Brisbane)
+10:00	Australia(Hobart)
+10:00	Russia(Vladivostok)
+10:30	Australia(Lord Howe Islands)
+11:00	New Caledonia(Noumea)
+12:00	New Zealand(Wellington, Auckland)
+12:45	New Zealand(Chatham Islands)
+13:00	Tonga(Nukualofa)

# Index

## A

About This Guide [ix](#)  
 Account Management [75](#)  
 Account Registration [75](#)  
 Adding Contacts [39](#)  
 Administrator password [30](#)  
 Anonymous Call [122](#)  
 Anonymous Call Rejection [123](#)  
 Answering Calls [90](#)  
 Area Code [81](#)  
 Attaching Stand [11](#)  
 Audio Settings [31](#)  
 Auto Answer [90](#)  
 Auto Redial [94](#)

## B

Backlight [24](#)  
 Basic Network Settings [19](#)  
 Blacklist [51](#)  
 Block Out [82](#)  
 Bluetooth [61](#)  
 Busy Lamp Field (BLF) [125](#)

## C

Call Completion [95](#)  
 Call Forward [104](#)  
 Call Mute [98](#)  
 Call History Management [55](#)  
 Call Hold/Resume [98](#)  
 Call Park [117](#)  
 Call Pickup [118](#)  
 Call Recording [128](#)  
 Call Return [97](#)  
 Call Transfer [111](#)  
 Call Waiting [113](#)  
 CE Mark Warning [vi](#)  
 Conference [113](#)  
 Contact Management [34](#)  
 Contrast [25](#)  
 Copyright [v](#)  
 Customizing Your Phone [23](#)

## D

Declaration of Conformity [vi](#)  
 Deleting Contacts [43](#)  
 Dial-now [80](#)  
 Dial Plan [78](#)  
 Do Not Disturb (DND) [99](#)  
 Documentation [7](#)  
 DSS Keys [67](#)

## E

Editing Contacts [42](#)  
 Ending Calls [91](#)

## G

General Settings [23](#)  
 Getting Started [9](#)

## H

Hardware Component Instructions [1](#)  
 Headset Use [59](#)  
 Headset Mode Activation/Deactivation [59](#)  
 Hotline [84](#)  
 Hot Desking [131](#)

## I

Icon Instructions [2](#)  
 Importing/Exporting Contact lists [49](#)  
 In This Guide [ix](#)  
 Incoming Intercom Calls [133](#)  
 Intercom [132](#)

## K

Key as Send [31](#)

## L

Language [26](#)  
 LED Instructions [4](#)  
 Limitation of Liability [155](#)  
 Line Keys [67](#)  
 Live Dialpad [83](#)  
 Local Conference [114](#)  
 Local Directory [36](#)

## M

Message Waiting Indicator [142](#)  
 Messages [140](#)  
 Multicast Paging [135](#)  
 Multiple Line Keys per Account [77](#)  
 Music on Hold [139](#)

## N

Network Conference [115](#)  
 Network Connection [11](#)

## P

Packaging Contents [9](#)  
 Phone Initialization [13](#)  
 Phone Installation [11](#)  
 Phone Status [18](#)

Phone User Interface	5
Placing Calls	88
Placing Calls to Contacts	46
Programmable Keys	75

## O

Outgoing Intercom Calls	133
Overview	1

## R

Recent Call In Dialing	92
Redialing Numbers	92
Registration	14
Regulatory Notices	155
Remote Phone Book	53
Replace Rule	78
Ring Tones	32

## S

Safety Instructions	155
Search Source List in Dialing	47
Searching for Contacts	47
Semi-attended Transfer	111
Service Agreements	155
System Customizations	59

## T

Touch Screen Display	14
Time & Date	27
Time Zones	157
Troubleshooting	145

## U

User Interfaces	5
-----------------	---

## V

Voice Mail	140
Volume	31

## W

Warranty	vi
Wallpaper	23
Web User Interface	5
WEEE Warning	vii